



Meaningful Innovation.

WEEE Number: 80133970

INSTRUCTION MANUAL

100AH RECHARGEABLE LI-ION BATTERY MODULE

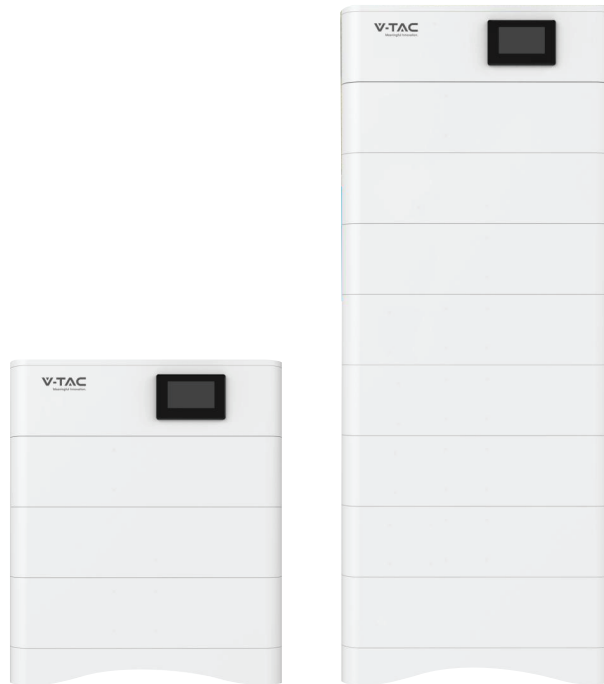

SKU	MODEL	DESCRIPTION
12151	OHS-HV100	HIGH VOLTAGE BATTERY CLUSTER CONTROL BOX
12002	OH-5K	51.2V 100AH RECHARGEABLE LI-ION BATTERY MODULE
12152	OH-BASE	BATTERY MODULE BASE

INTRODUCTION

Thank you for selecting and buying V-TAC Product. V-TAC will serve you the best. Please read these instructions carefully & keep this user manual handy for future reference. If you have any another query, please contact our dealer or local vendor from whom you have purchased the product. They are trained and ready to serve you at the best.

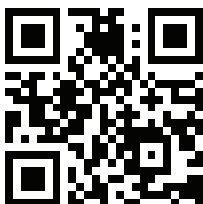

MULTI-LANGUAGE MANUAL QR CODE

Please scan the QR code to access the manual in multiple languages.



FR

Les piles
et batteries
se recyclent

À DÉPOSER
EN MAGASIN



À DÉPOSER
EN DÉCHÈTERIE



OU

Points de collecte sur www.quefairedemesdechets.fr

IN CASE OF ANY QUERY/ISSUE WITH THE PRODUCT, PLEASE REACH OUT TO US AT: SUPPORT@V-TAC.EU
FOR MORE PRODUCTS RANGE, INQUIRY PLEASE CONTACT OUR DISTRIBUTOR OR NEAREST DEALERS.

V-TAC EUROPE LTD. BULGARIA, PLOVDIV 4000, BUL.L.KARAVELOW 9B

Content

1. Introduction	3
1.1 Important Safety Instructions	3
1.2 Symbols	4
1.3 Brief Introduction	5
1.4 Product Properties	5
2. Product Specification	6
2.1 Size and Weight	6
2.2 Performance Parameter	7
2.3 Equipment Interface Instruction	8
3. OHS'S User Interface	10
3.1 Main Interface	10
3.2 Cell Voltage	11
3.3 Cell Temperature	11
3.4 Heating Temperature	12
3.5 Relay Status	12
3.6 Other	13
3.6.1 Heating Information	13
3.6.2 Insulation Resistense	14
3.6.3 Diagnostic Information	14
3.6.4 Cumulative Time Information	15
3.7 Set Up	15
4. Xiaodan Energy Storage App	16
4.1 App download	16
4.1.1 Android version	16
4.1.2 iOS version	17
4.2. Log in and register	17
4.2.1 Log in	17
4.2.2 Register	18
4.2.3 Experience login	19
4.3. Equipment distribution network	20
4.3.1 Overview	20
4.3.2 Distribution process	20
4.4. App page	25
4.4.1 Equipment	25
4.4.2 Data details	28
4.4.3 Mine	28
4.4.4 Message	33
4.4.5 App settings	34
5. Installation and Configuration	36
5.1 Preparation for installation	36
5.1.1 Safety Requirement	36
5.1.2 Environmental requirements	36

5.1.3 Tools and data	37
5.1.4 Technical preparation	37
5.1.5 Unpacking inspection	37
5.2 Equipment installation	39
5.2.1 Installation Steps	39
5.2.2 Battery parameter settings on the inverter	41
6. Installation and Configuration	41
6.1 Battery system usage and operation instructions	41
6.2 Alarm description and processing	42
6.3 Analysis and treatment of common faults	42
7 Battery Module Storage	43
8 Maintenance	44



1. Introduction

1.1 Important Safety Instructions



Danger!

- Please do not put the battery into water or fire, in case of explosion or any other situation that might endanger your life.
- Please connect wires properly while installation, do not reverse connect. To avoid short circuit, please do not connect positive and negative poles with conductor on the same device.
- Please avoid any form of damage to battery, especially stab, hit, trample or strike.



Danger!

- Please shut off the power completely when removing the device or reconnecting wires during the daily use or it could cause the danger of electric shock.
- Please use dry powder extinguisher to put out the flame when encountering a fire hazard, liquid extinguisher could result in the risk of explosion.
- For your safety, please do not arbitrarily dismantle any component in any circumstances. The maintenance must be implemented by authorized technical personnel or our company's technical support. Device breakdown due to unauthorized operation will not be covered under warranty.



Caution!









- Our products have been strictly inspected before shipment. Please contact us if you find any abnormal phenomena such as device outer case bulging.
- The product shall be grounded properly before use in order to ensure your safety.
- To assure the proper use please make sure parameters among the relevant device are compatible and matched.
- Please do not mixed-use batteries from different manufacturers, different types and models, as well as old and new together.



Caution!

- Ambient and storage method could impact the product life span, please comply with the operation environment instruction to ensure device works in proper condition.
- For long-term storage, the battery should be recharged once every 6 months, and the amount of electric charge shall exceed 80% of the rated capacity.
- Please charge the battery in 18 hours after it fully discharged or over-discharging protection mode is activated.
- Formula of theoretical standby time: $T=C/I$ (T is standby time, C is battery capacity, I is total current of all loads).

1.2 Symbols

Symbols	Description
	Warning electric shock.
	Caution! Warning! Reminding. Safety related information. Risk of battery system failure or life cycle reduces.
	Warning Fire. Do not place near flammable material
	Do not place near open flame.
	Read the product and operation manual before operating the battery system!
	Grounding.
	The certificate label for EMC/CE.
	The certificate label for UKCA.
	Label for Waste Electrical and Electronic Equipment (WEEE) Directive (2012/19/EU)

1.3 Brief Introduction

51.2V100AH lithium iron phosphate battery system is a standard battery system unit, customers can choose a certain number of 51.2V100AH according to their needs, by connecting series to form a larger capacity battery pack, to meet the user's long-term power supply needs. The product is especially suitable for energy storage applications with high operating temperatures, limited installation space, long power backup time and long service life.

1.4 Product Properties

51.2V100AH energy storage product's positive electrode materials are lithium iron phosphate, battery cells are managed effectively by BMS with better performance, the system's features as below:

- The whole module is non-toxic, non-polluting and environmentally friendly;
- Cathode material is made from LiFePO₄ with safety performance and long cycle life
- Battery management system with better performance, possesses protection function like over-discharge, over-charge, over-current, abnormal temperature.
- Self-management on charging and discharging, Single core balancing function.
- Intelligent design configures integrated inspection module.
- Flexible configuration, multiple battery modules can be in parallel for expanding capacity and power.
- Flexible configurations allow parallel of multi battery for longer standby time.
- Self-ventilation with lower system noise.
- Less battery self-discharge, then recharging period can be up to 10 months during the storage.
- No memory effect so that battery can be charged and discharged shallowly.
- With wide range of temperature for working environment, -10°C ~ +55°C, circulation span and discharging performance are well under high temperature.

2. Product Specification

2.1 Size and Weight

51.2V100Ah Module

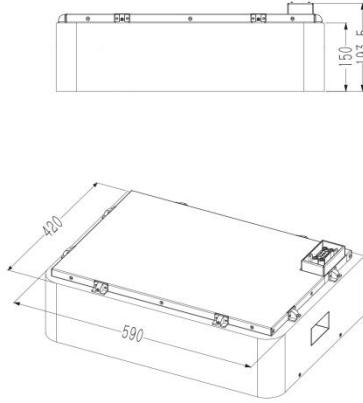

Module Cluster

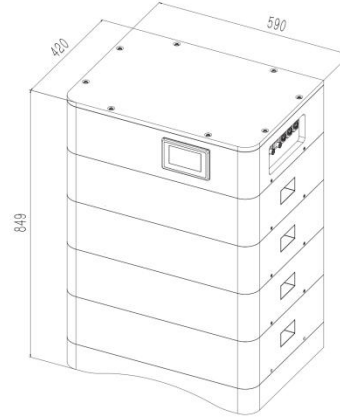

High voltage battery cluster control box

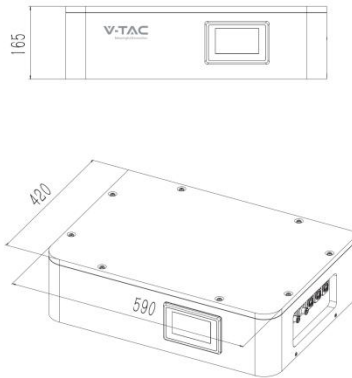

Battery module base

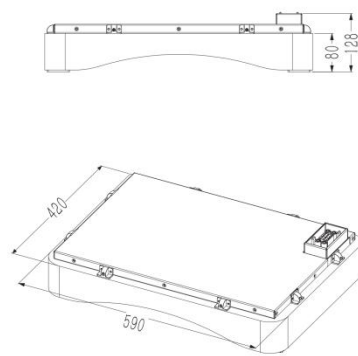

Table 2-1 Device size

Product	Nominal Voltage (V)	Nominal Capacity (Ah)	Dimension (mm)	Weight (Kg)
OHS15K-100	153.6	100	590*420*698	173.9
OHS20K-100	204.8	100	590*420*849	222.4
OHS25K-100	256	100	590*420*1000	270.9
OHS30K-100	307.2	100	590*420*1151	319.4
OHS35K-100	358.4	100	590*420*1302	367.9
OHS40K-100	409.6	100	590*420*1453	416.4

2.2 Performance Parameter

Table 2-2 performance parameter

Technical specification	15KWH	20KWH	25KWH	30KWH	35KWH	40KWH
Installation Mode	Stackable					
Battery Type	LifePO4(LFP)					
Module Energy(kWh)	5.12					
Module Nominal Voltage(V)	51.2					
Module Capacity(Ah)	100					
System Model	OHS15K-100	OHS20K-100	OHS25K-100	OHS30K-100	OHS35K-100	OHS40K-100
Battery Module Qty InSeries(Optional)	3	4	5	6	7	8
System Nominal Voltage(V)	153.6	204.8	256.0	307.2	358.4	409.6
System Nominal Capacity(KWh)	15.36	20.48	25.60	30.72	35.84	40.96
Usable Capacity(KWh)	12.29	16.38	20.48	24.58	28.67	32.77
Dimension (mm)	590*420*698	590*420*849	590*420*1000	590*420*1151	590*420*1302	590*420*1453
Weight (Kg)	173.9	222.4	270.9	319.4	367.9	416.4
Recommend Charge/Discharge Current (A)	40					
Recommend charging method declared by the manufacturer	Charge at constant current 50A until cell voltage reaches 3.5V, then charge at constant current 5A until cell voltage reaches 3.6V,					
Communicaiton	CAN					
Ingress Protection	IP65					
Altitude	≤2000m					
Cycle Life	25±2°C,0.5C/0.5C,EOL70%≥6000					
Monitoring Parameters	System voltage,Current,cell voltage,cell temperature					
SOC	Intelligent algorithm					
Working Temperature	0°C~45°C Charge -10°C ~-55°C Discharge					
Storage Temperature	0~35°C					

2.3 Equipment Interface Instruction

2.3.1 This section details the front and back interface functions of the battery pack

Product Front Interface

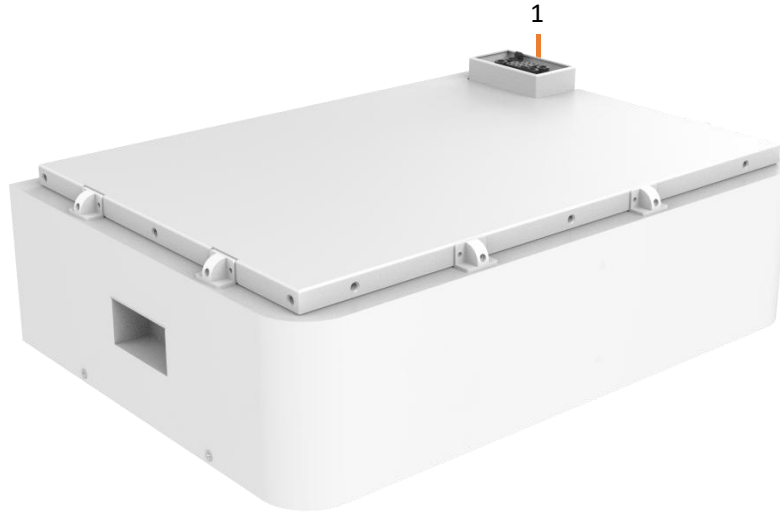

Control Box Module Front Interface

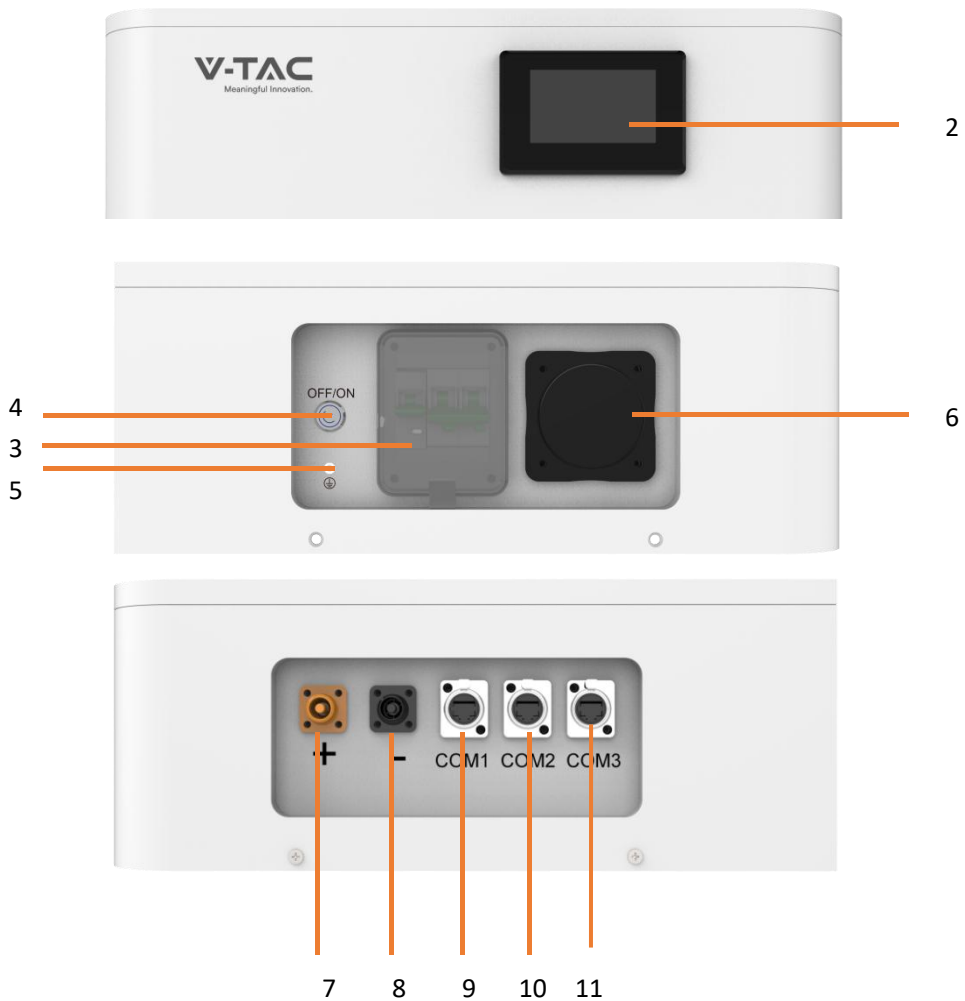
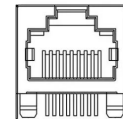
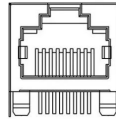
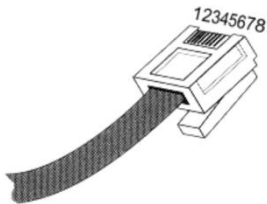

Table 2-3 Interface Definition

Item	Name	Definition
1	Power Connector	For battery pack connect in series
2	Screen	Show battery information
3	Air Switch	Current Protection
4	BMS ON/OFF	Start BMS
5	Ground Point	Ground Point
6	WiFi	WiFi
7	Positive Output	DC + To Inverter
8	Negative Output	DC - To Inverter
9	Communication Port	Communication for debugging
10	Communication Port	Communication to inverter
11	Communication Port	Communication between battery cluster

2.3.2 CAN/485 interface definition



RS485/CAN	RS485/CAN
Communication to inverter	Communication between battery cluster

	PIN position	Color	Definition
RS485/CAN	PIN1	Orange/White	485A1
	PIN2	Orange	485B1
	PIN3	Green/White	GND
	PIN4	Blue	CAN1H
	PIN5	Blue/White	CAN1L
	PIN6	Green	GND
	PIN7	Brown/White	CAN0H
	PIN8	Brown	CAN0L

3. OHS' S User Interface

3.1 Main Interface



NO.	Description	Function
1	SOC	Display real-time SOC value of energy storage system
2	Voltage	Display real-time voltage
3	Temperature	Displays the maximum and minimum battery temperatures
4	Voltage	Displays real-time maximum and minimum cell voltages
5	Current	Display battery real-time current
6	System status	Display battery fault name (For details, see Table 6-1)

3.2 Cell Voltage

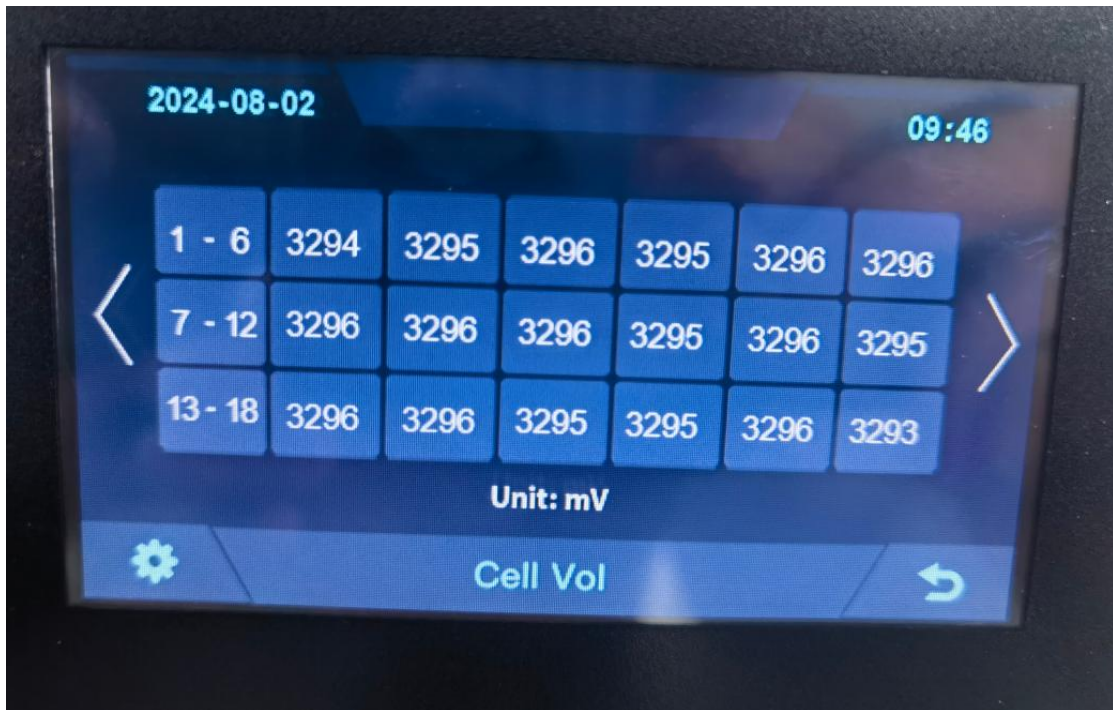

3.3 Cell Temperature

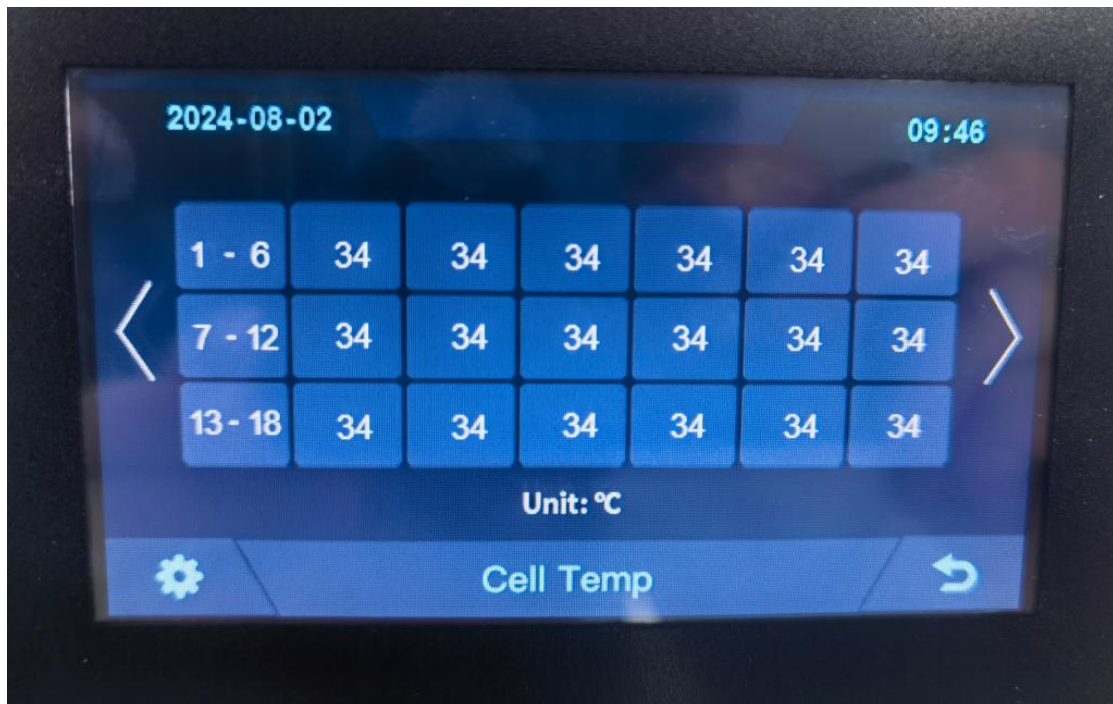

3.4 Heating Temperature



3.5 Relay Status

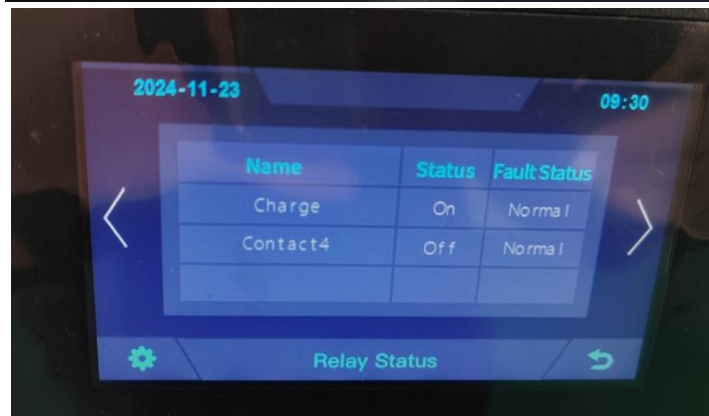
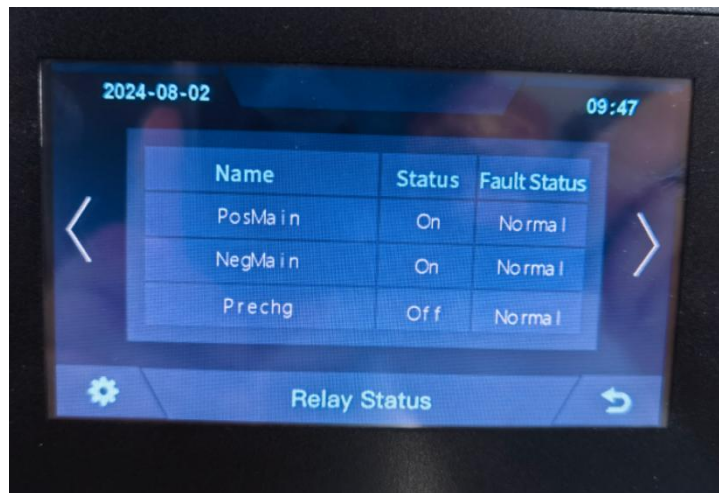

3.6 Other

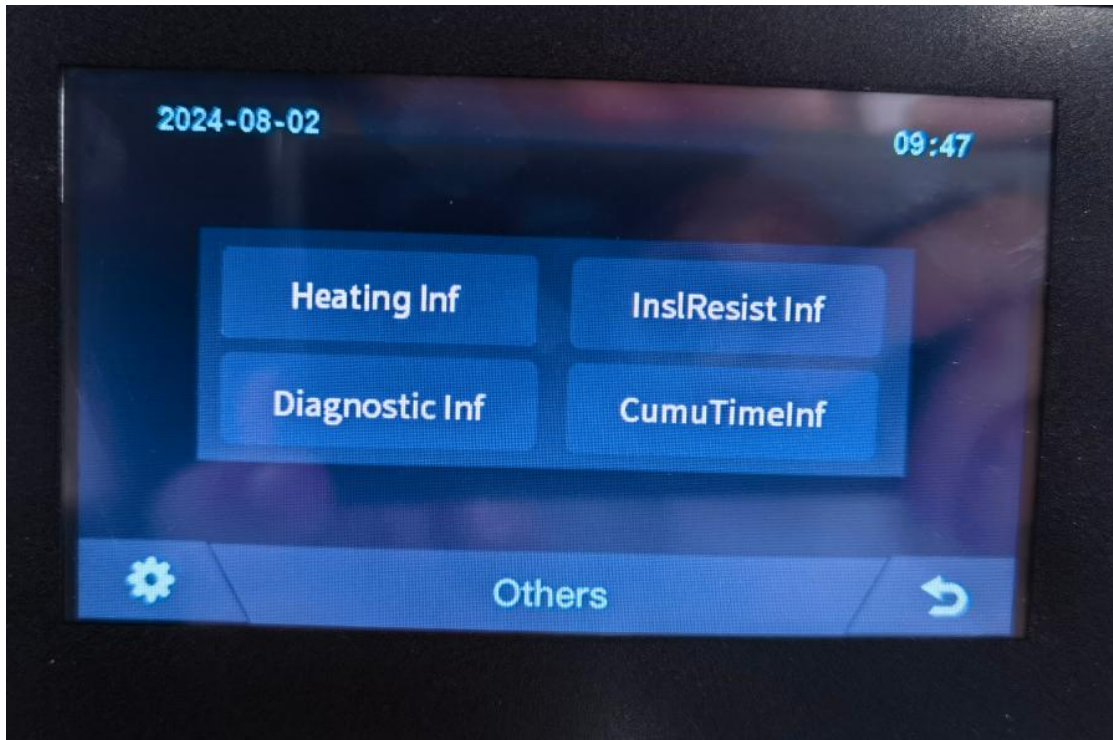

3.6.1 Heating Information



3.6.2 Insulation Resistense



3.6.3 Diagnostic Information

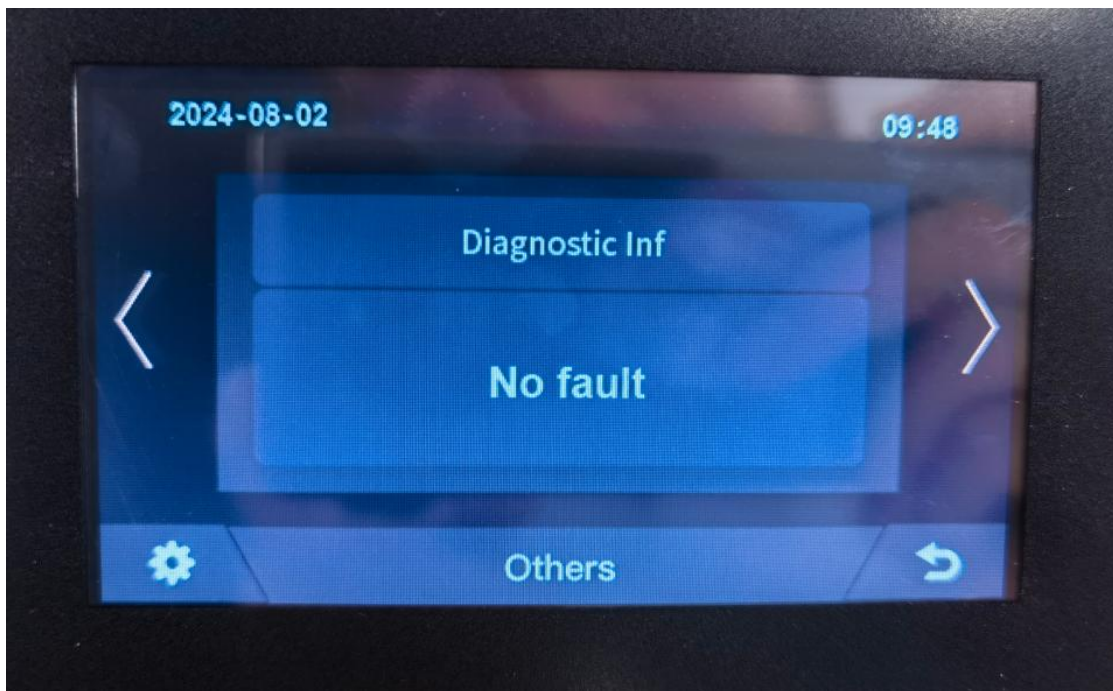

3.6.4 Cumulative Time Information

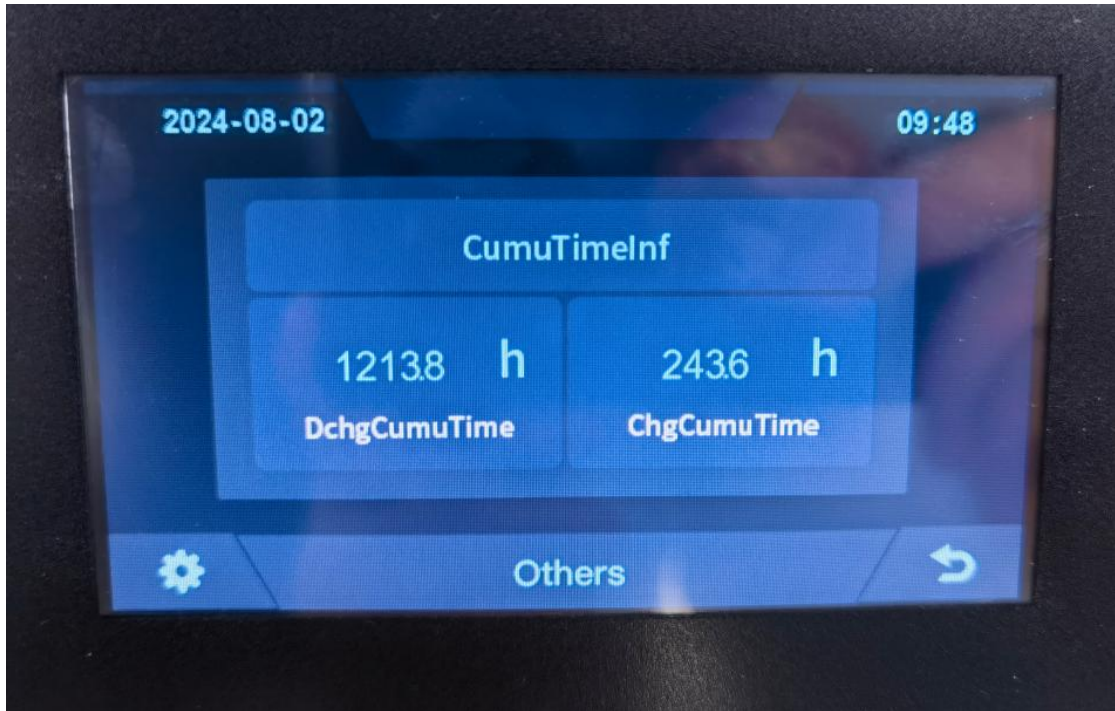

3.7 Set Up



4. Xiaodan Energy Storage App

4.1 App download

4.1.1 Android version

1. Enter the official website of Youdan Technology <https://www.udantech.com/#/> , click on the "SAAS Application" column in the top navigation bar, pull down to the mobile app application module, and you can see the mobile WeChat Mini Program and App application download.

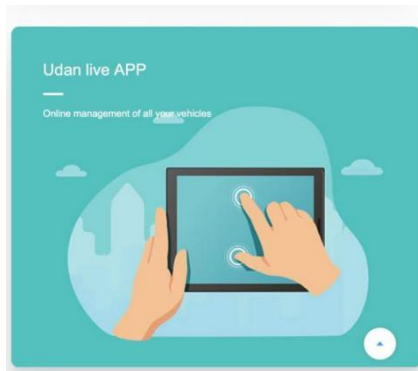
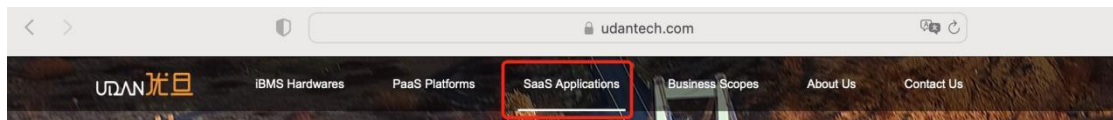

Wechat mini program scan code experience



APP download

4.1.2 iOS version

Enter the mobile App Store, search for "Xiaodan Energy Storage", and you can download and install it.

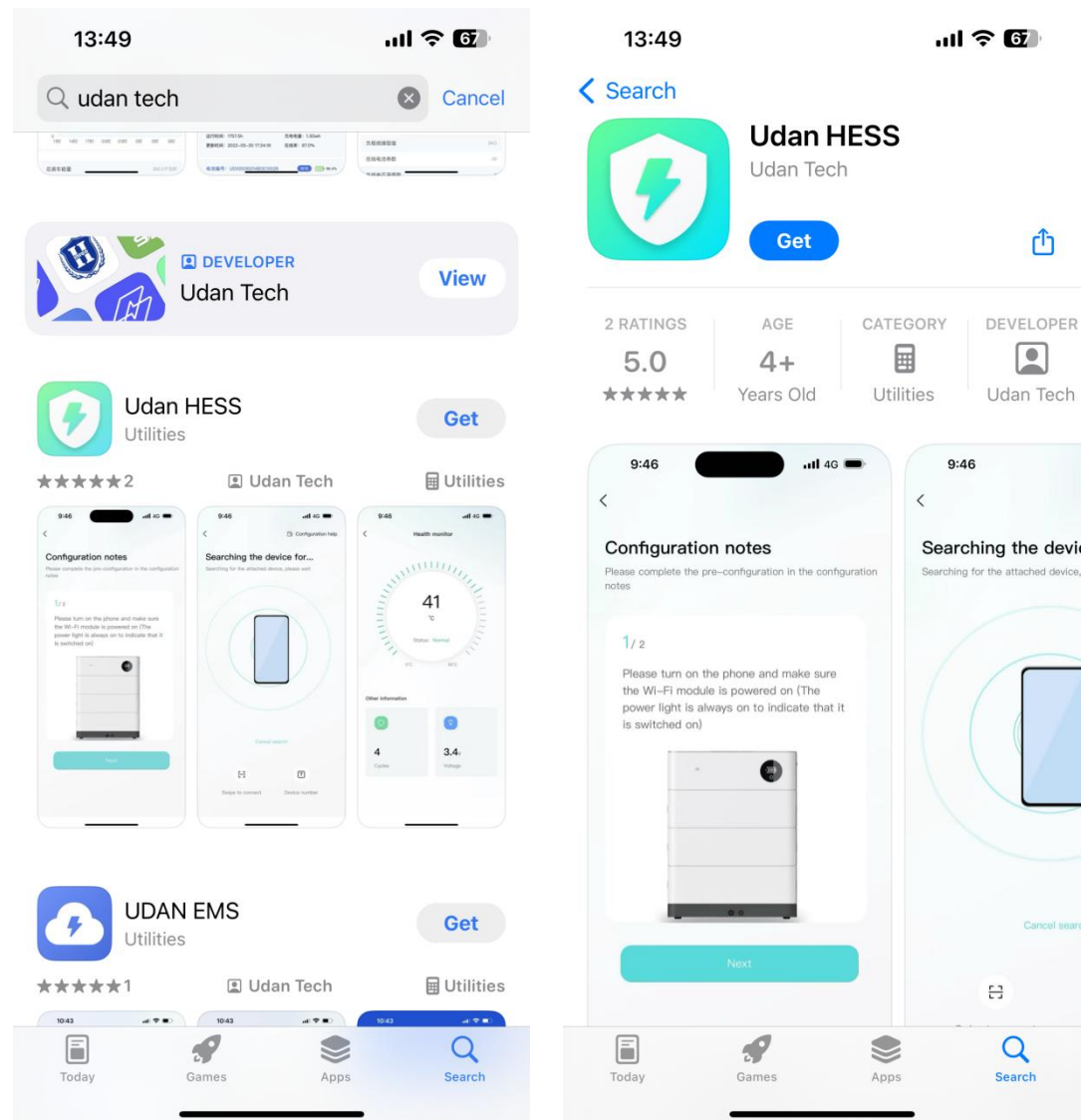

4.2. Log in and register

4.2.1 Log in

- After opening the APP, enter the login interface to log in with your account.
- Currently supports logging in through email accounts

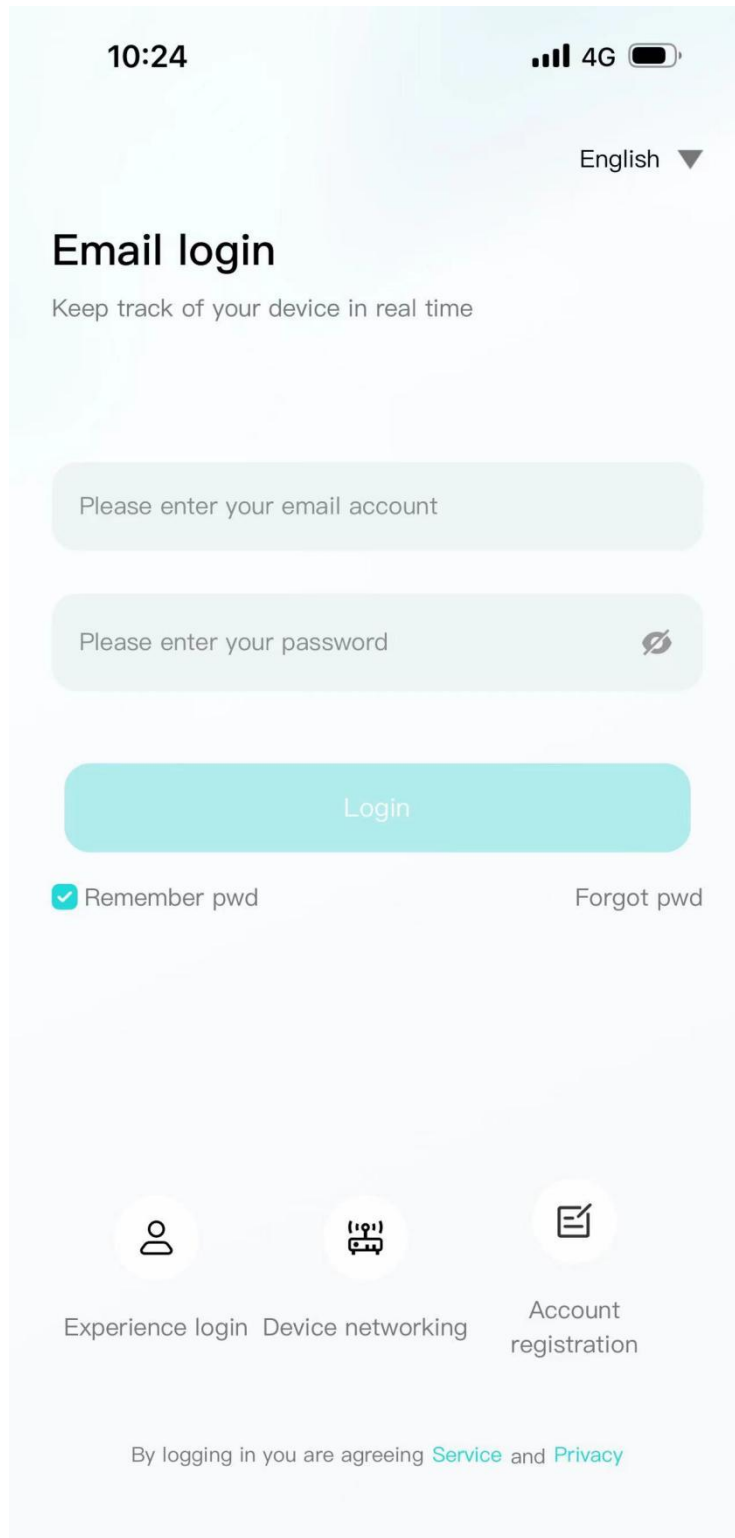

4.2.2 Register

- At the bottom of the login page, click the "Account Registration" button to enter the registration process.

- Currently, you can register with an email account. After registration, you need to go through the device verification process and enter the device SN code or device QR code for identification.

10:24 4G

<

Account Registration

Please enter your email and password

Please enter your email account

Please enter your password

Enter the code

Get code

Next

10:00

<

Device verification

Please fill in the information of the equipment you purchased

Product serial number *

Please enter the serial number or scan the QR code

The following information is for after-sales use only and for no other purpose

Contact person *

Please enter

Contact number *

It is only used as a contact in case of equipment emergency

Service address *

Please enter the address where the device is installed

Finish

No equipment yet? Try the login experience

4.2.3 Experience login

- At the bottom of the login page, click the "Experience Login" button to experience the app function without registration as a tourist.

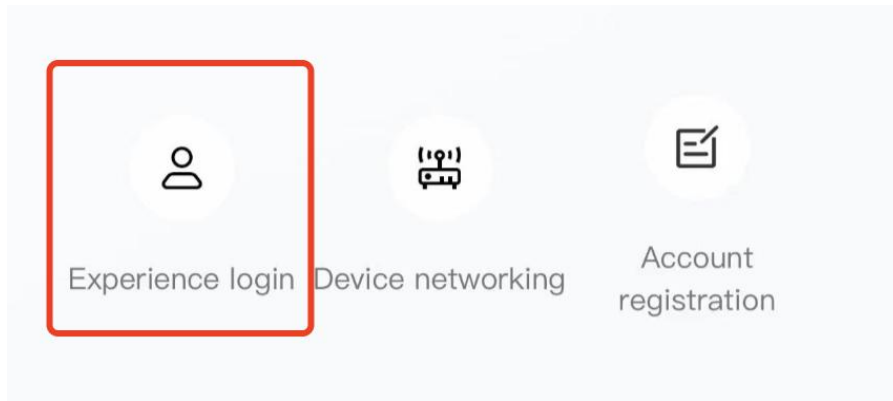

4.3. Equipment distribution network

4.3.1 Overview

Device distribution network refers to connecting devices to the Cloud Computing Platform to help users obtain real-time device data information.

4.3.2 Distribution process

1. Preparation before distribution: Ensure that the **device is on** , turn on the **mobile phone Bluetooth and wireless LAN** functions.

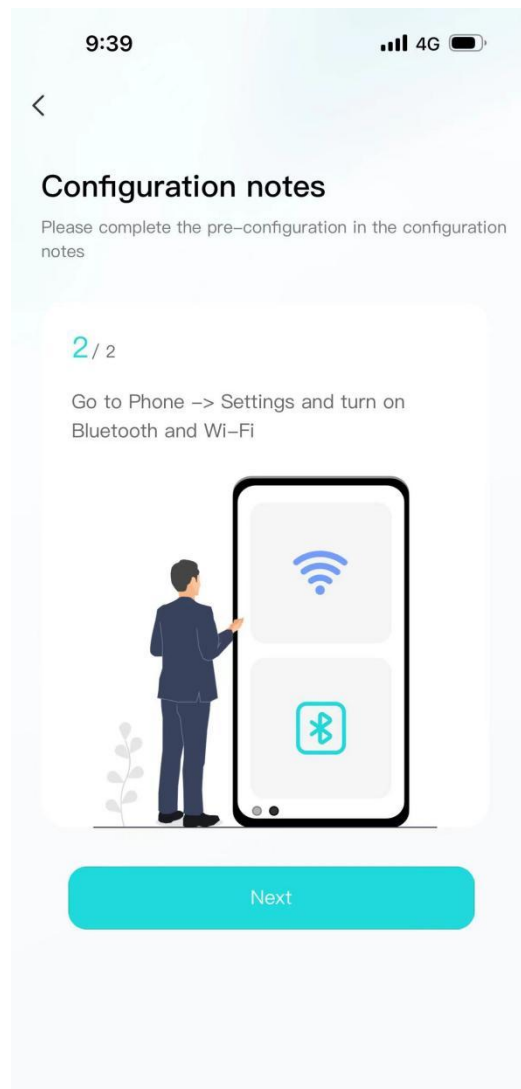
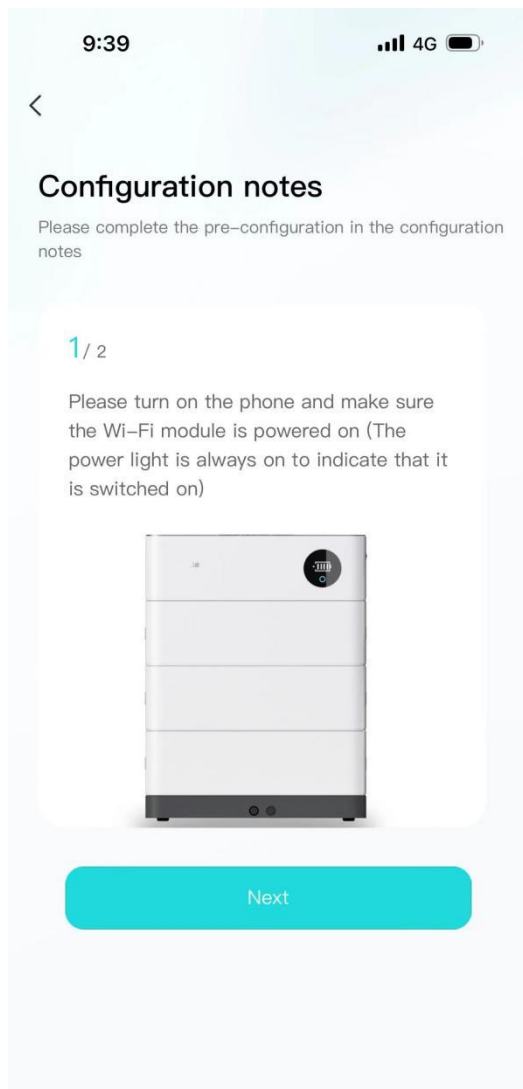

2. Connected devices: The current App supports **Bluetooth search, device scanning, and manual input of SN code** .

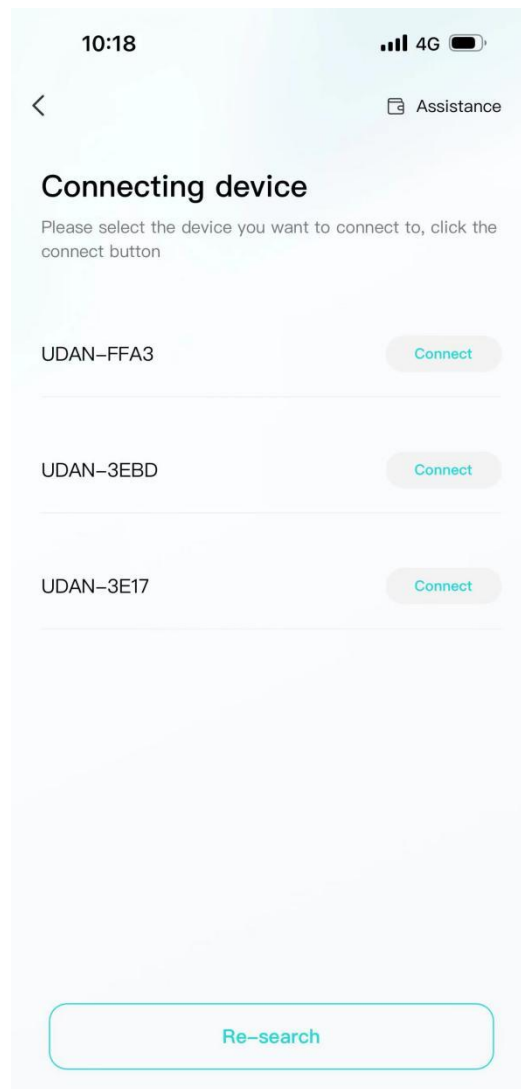
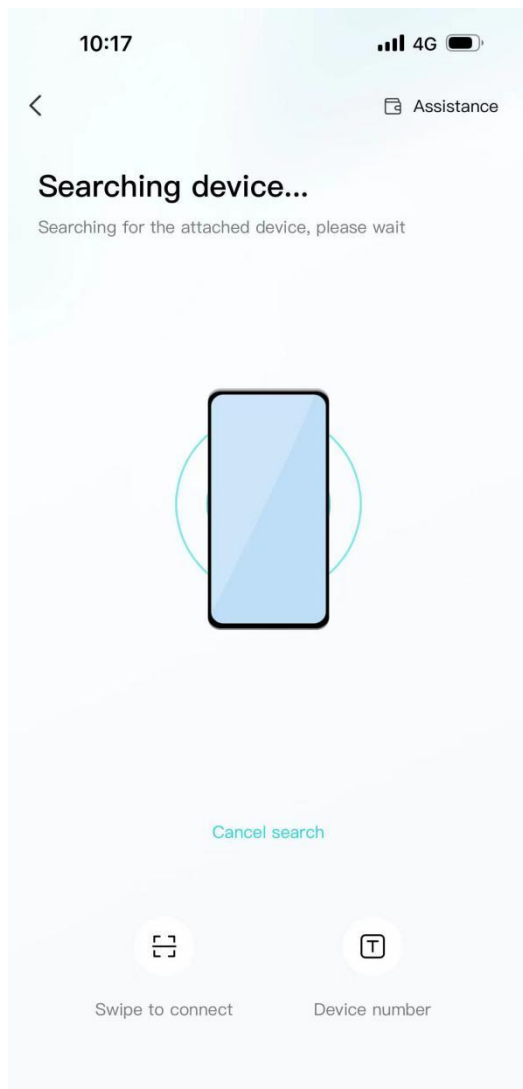

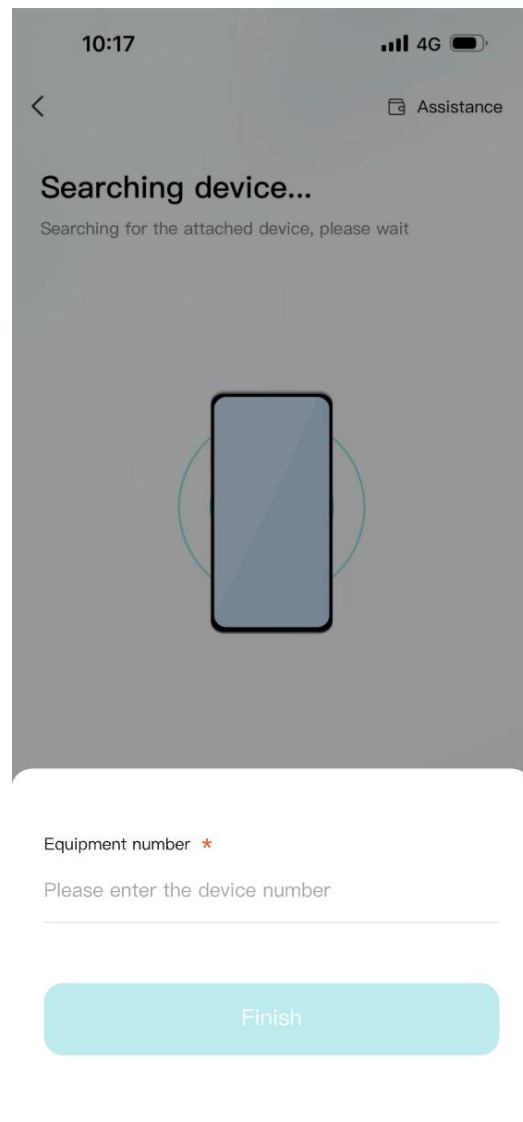
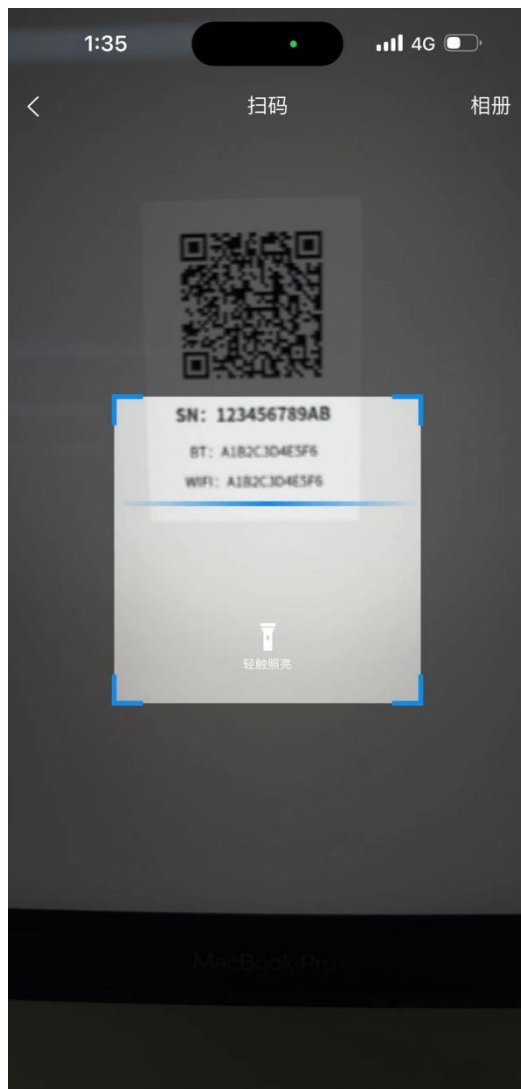

3. Connect to WiFi: After the device is connected, enter the WiFi connection process.
 - Select the WiFi you want to use and click the "Connect" button. Enter the WiFi password and click the "Finish" button to distribute the network.

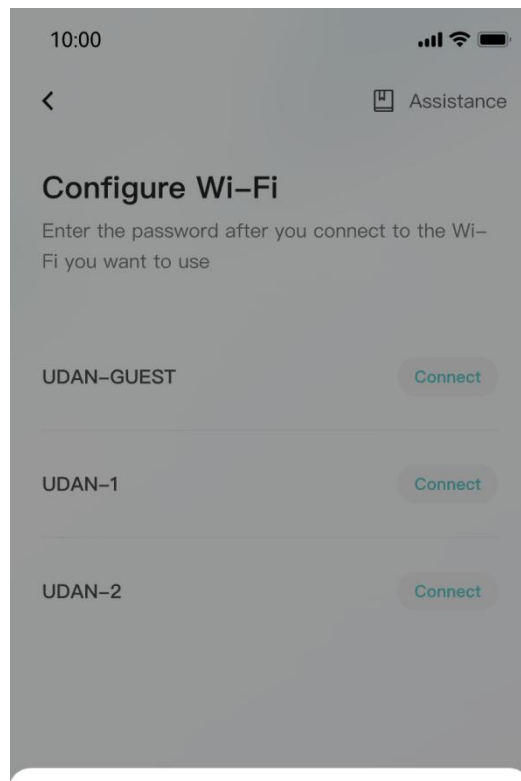
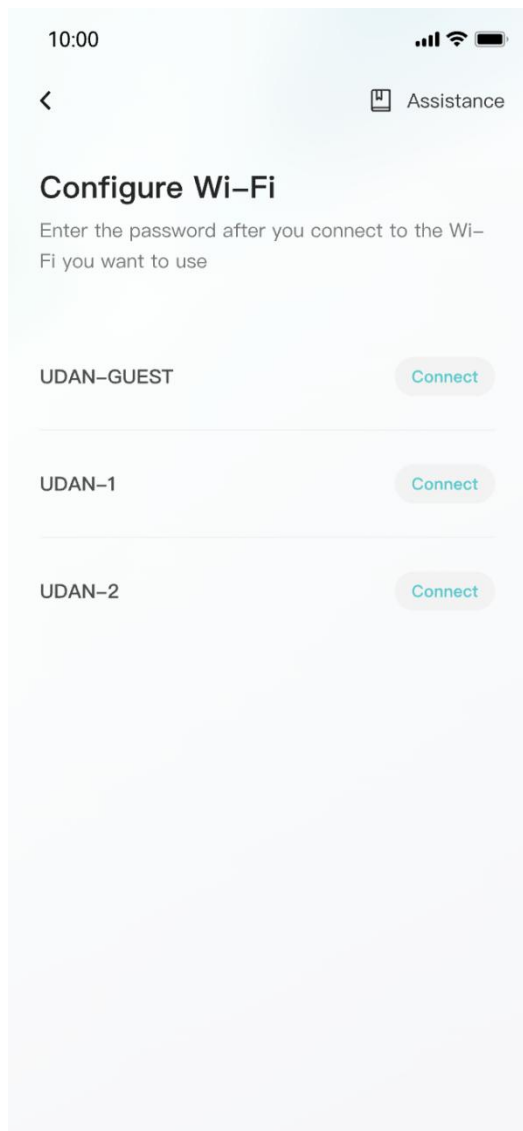

Wi-Fi Password *

Please enter the wireless network password

Finish

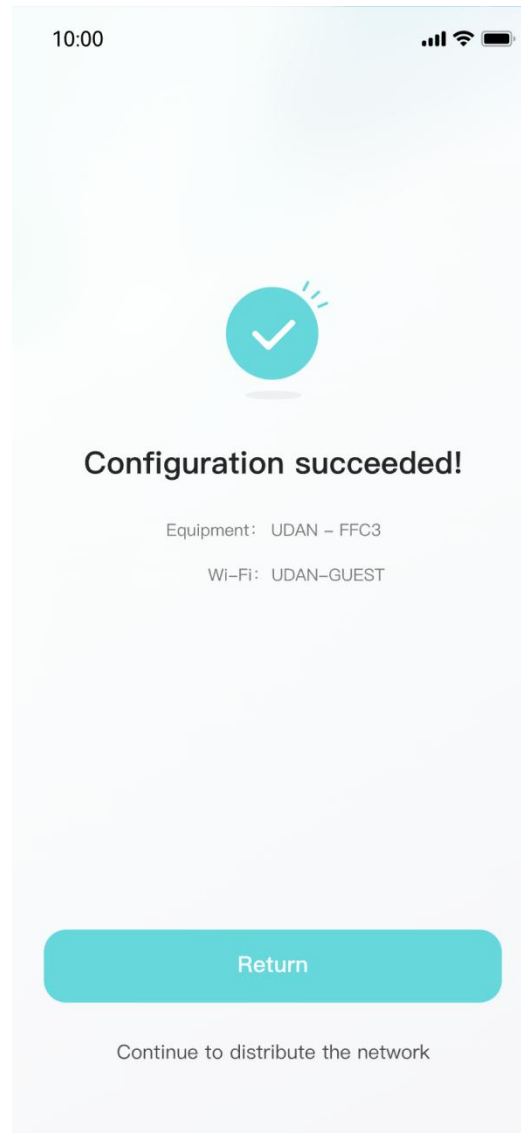
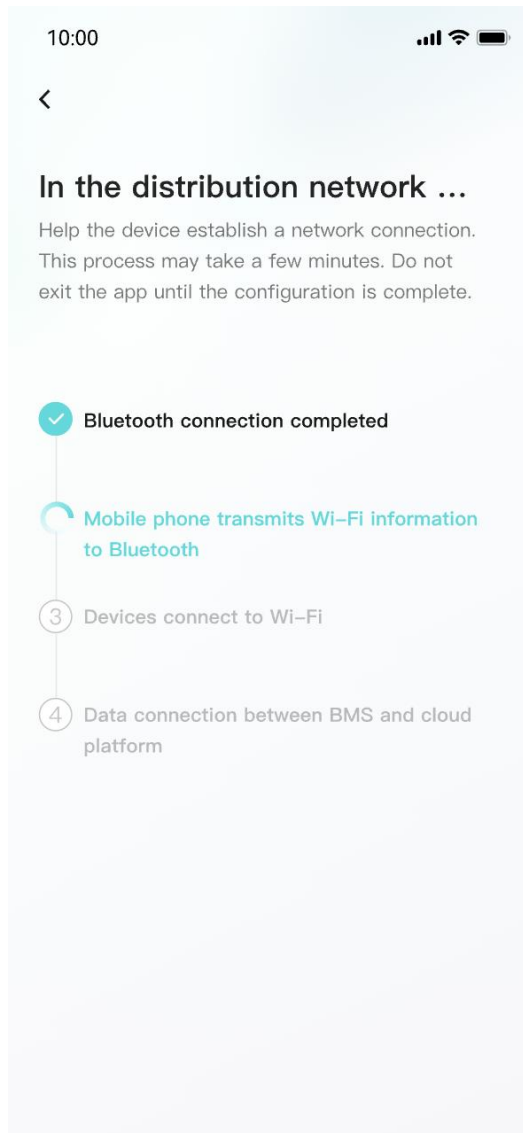

4.4. App page

4.4.1 Equipment

The device homepage is used to display the currently managed device information.

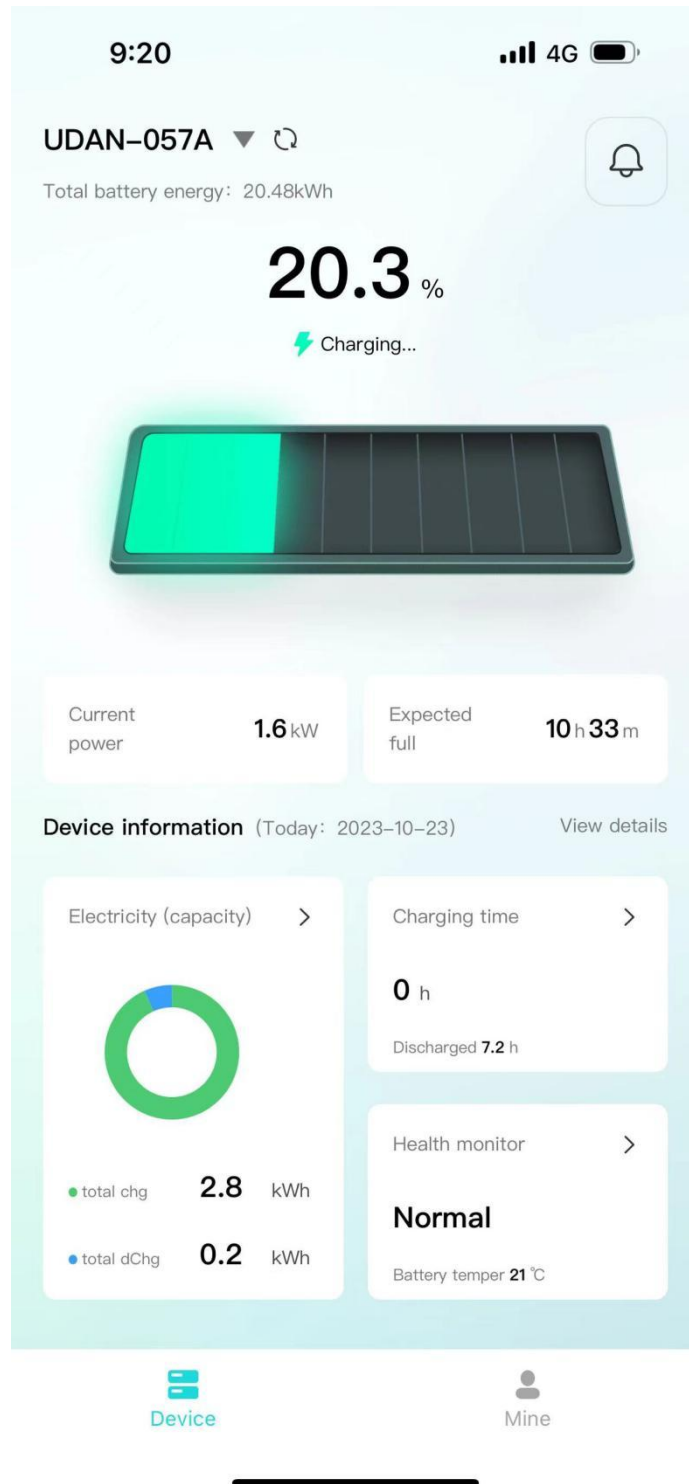

- The top area displays the device name, battery energy, and message entry.

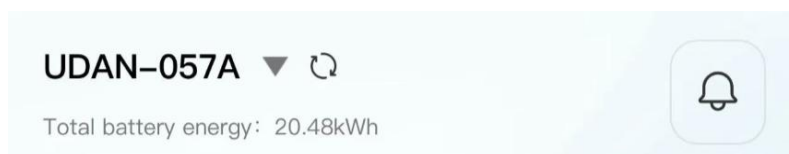

- Middle area: Displays the current battery charging and discharging status, battery percentage, current power, and estimated full time.

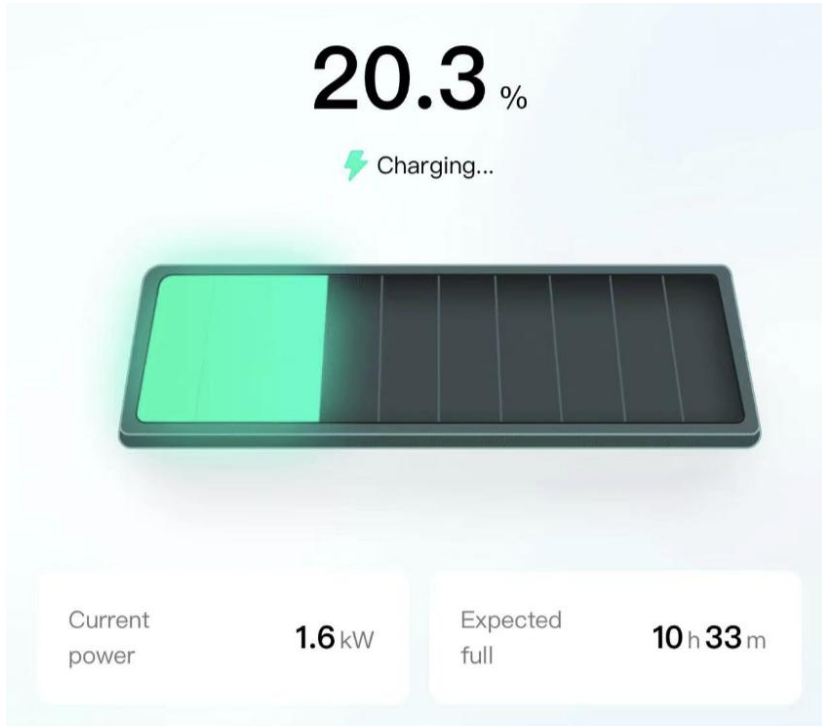

- The bottom area: Displays the device battery, charging time, and health check overview data of the day in the form of a card. You can click the corresponding card to view the details.



4.4.2 Data details

Display the data details of the current device, and view the battery, charging and discharging power, and charging and discharging time data separately, and support time filtering.

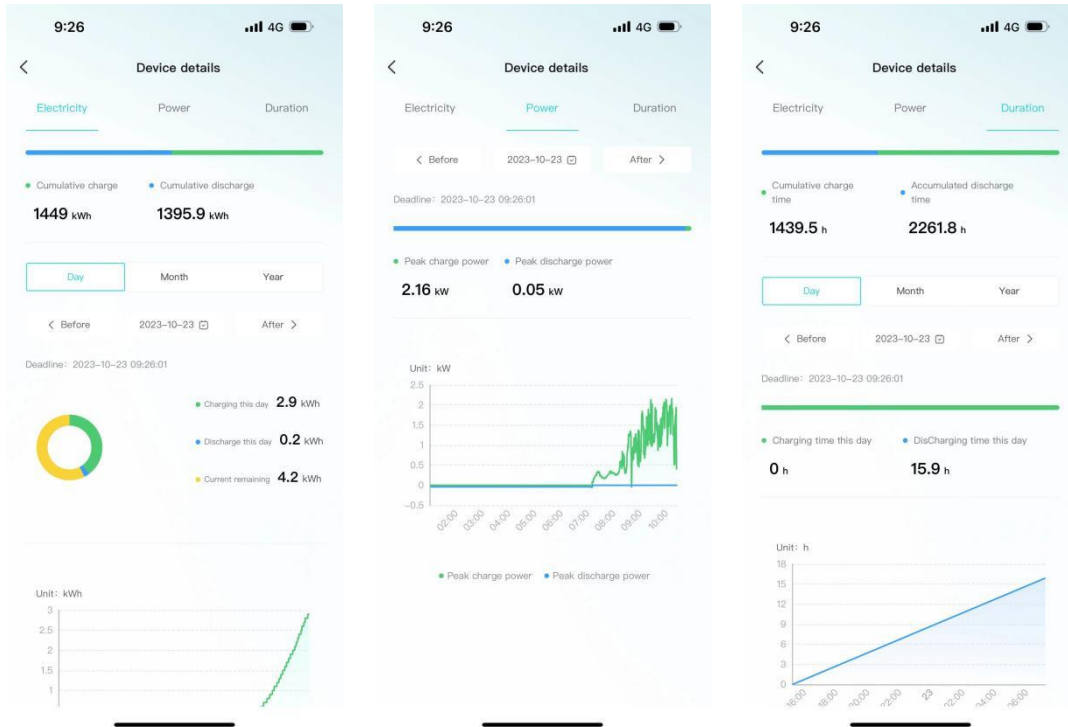

4.4.3 Mine

My page allows users to view **my devices**, **add devices**, **configure WiFi**, **software updates**, **after-sales services**, **problem feedback**, **app settings** .

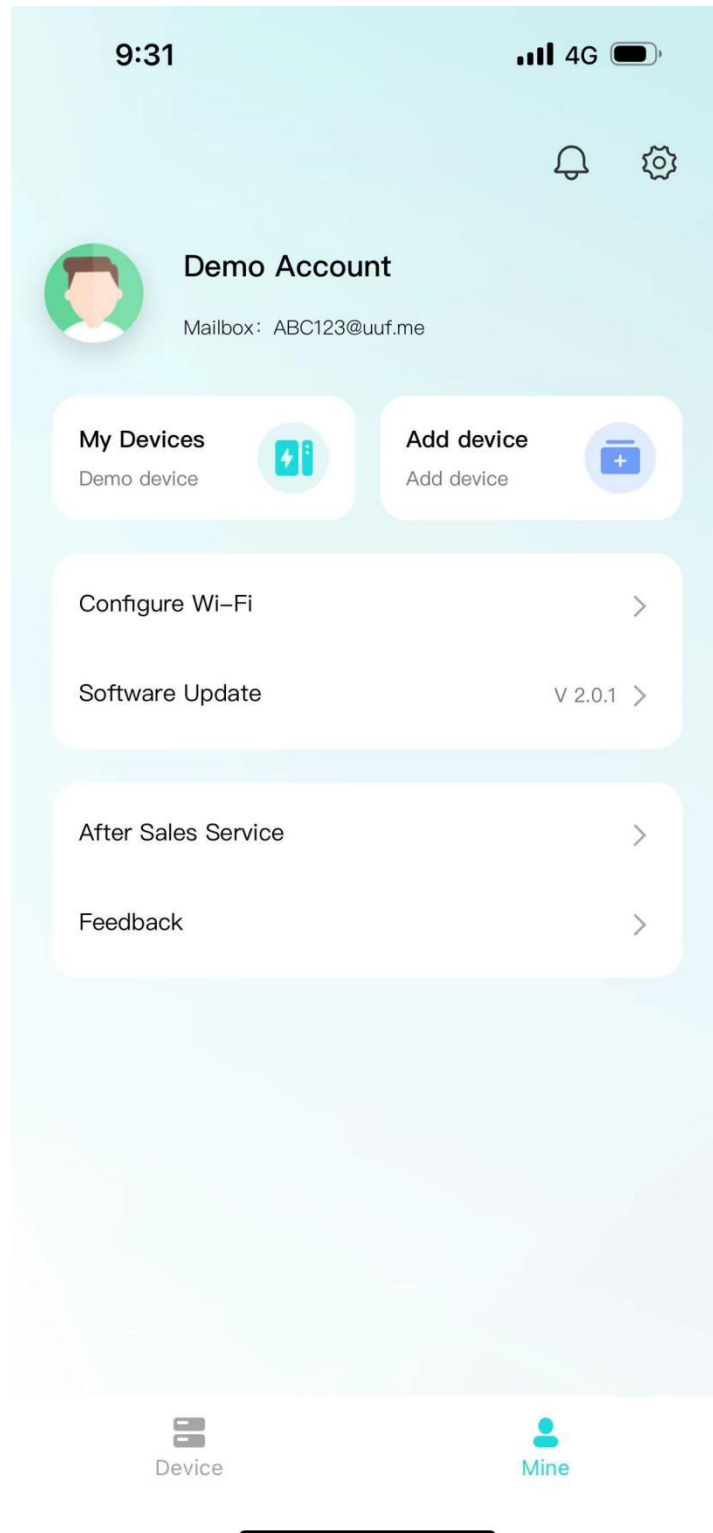

- Click "My Devices" to enter Facility Management. You can view all devices managed under the current account, switch devices displayed on the homepage, unbind devices, and other operations.

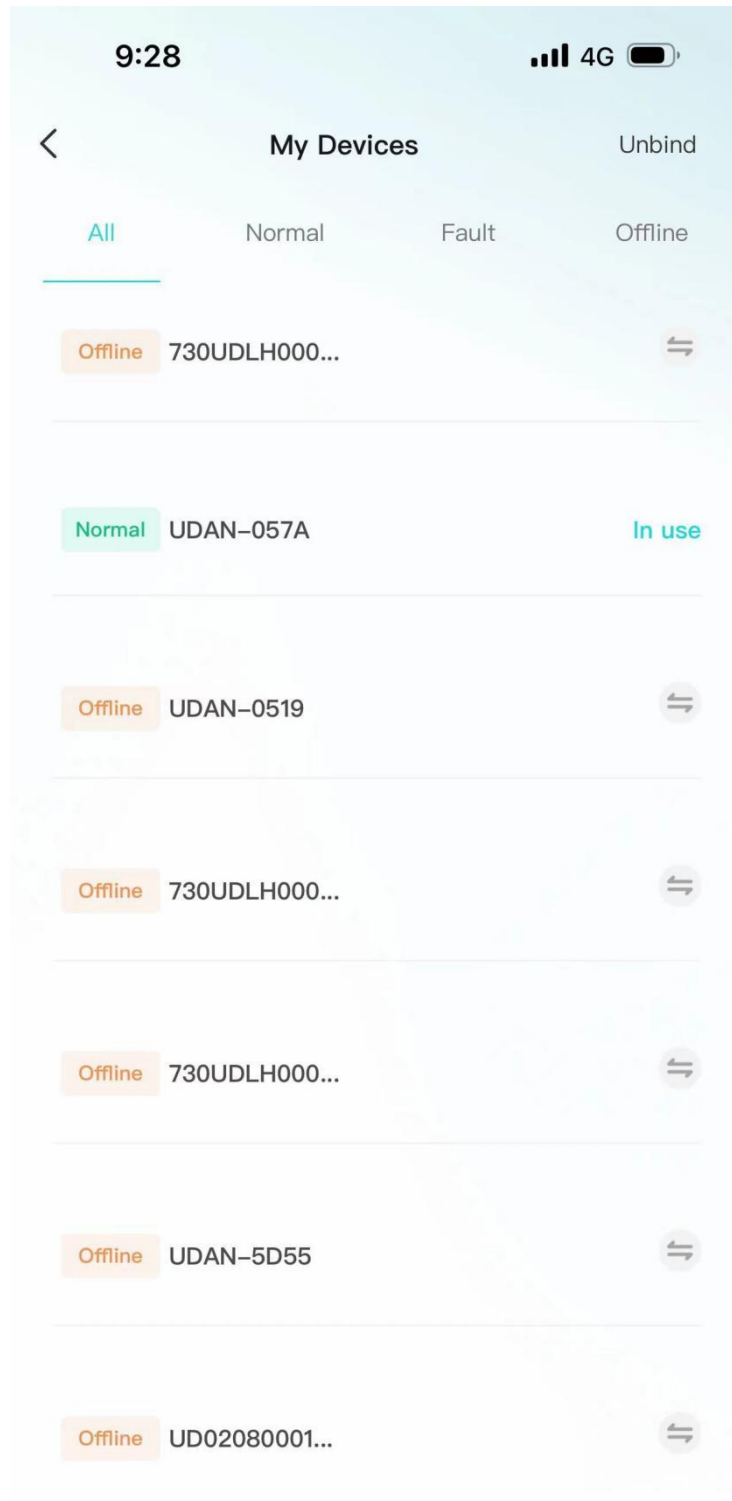

- Click "Add Device" to enter the code scanning page.
- Click "Equipment Distribution Network" to enter the equipment distribution network

process.

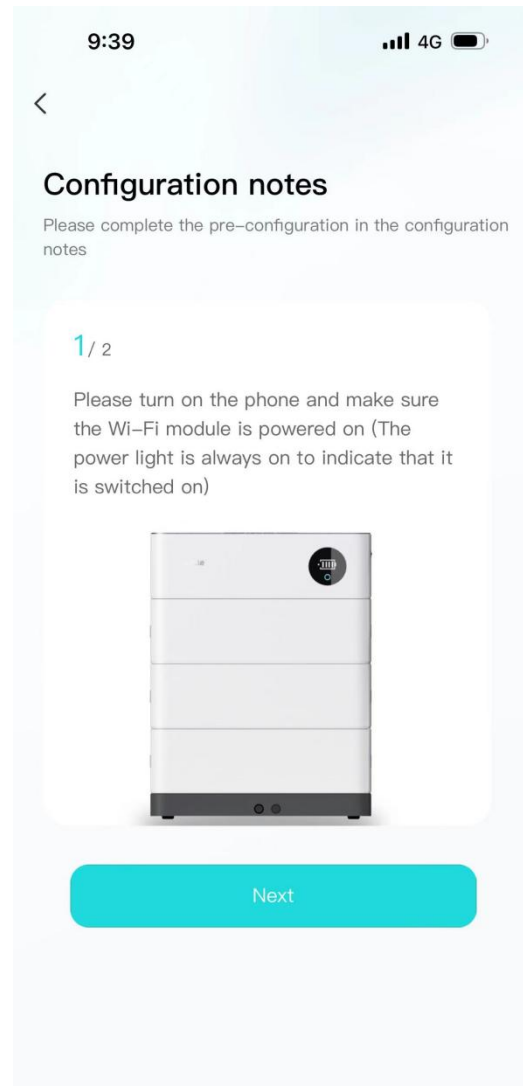
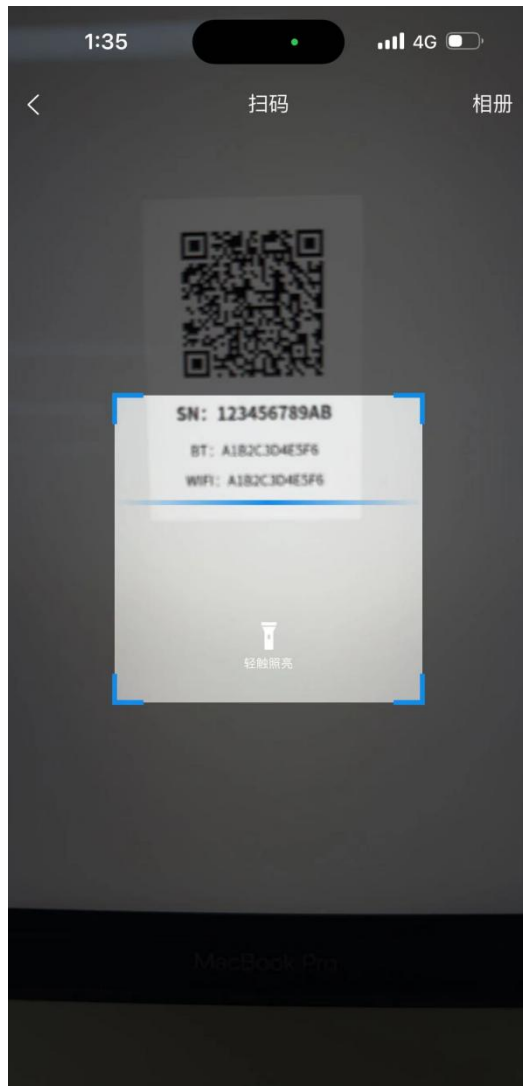

- After clicking "software update", it will enter the version detection. If there is a new version, it will be updated.
- Click "after-sales services" and enter the after-sales services page to display the after-sales services declaration of the current supplier.

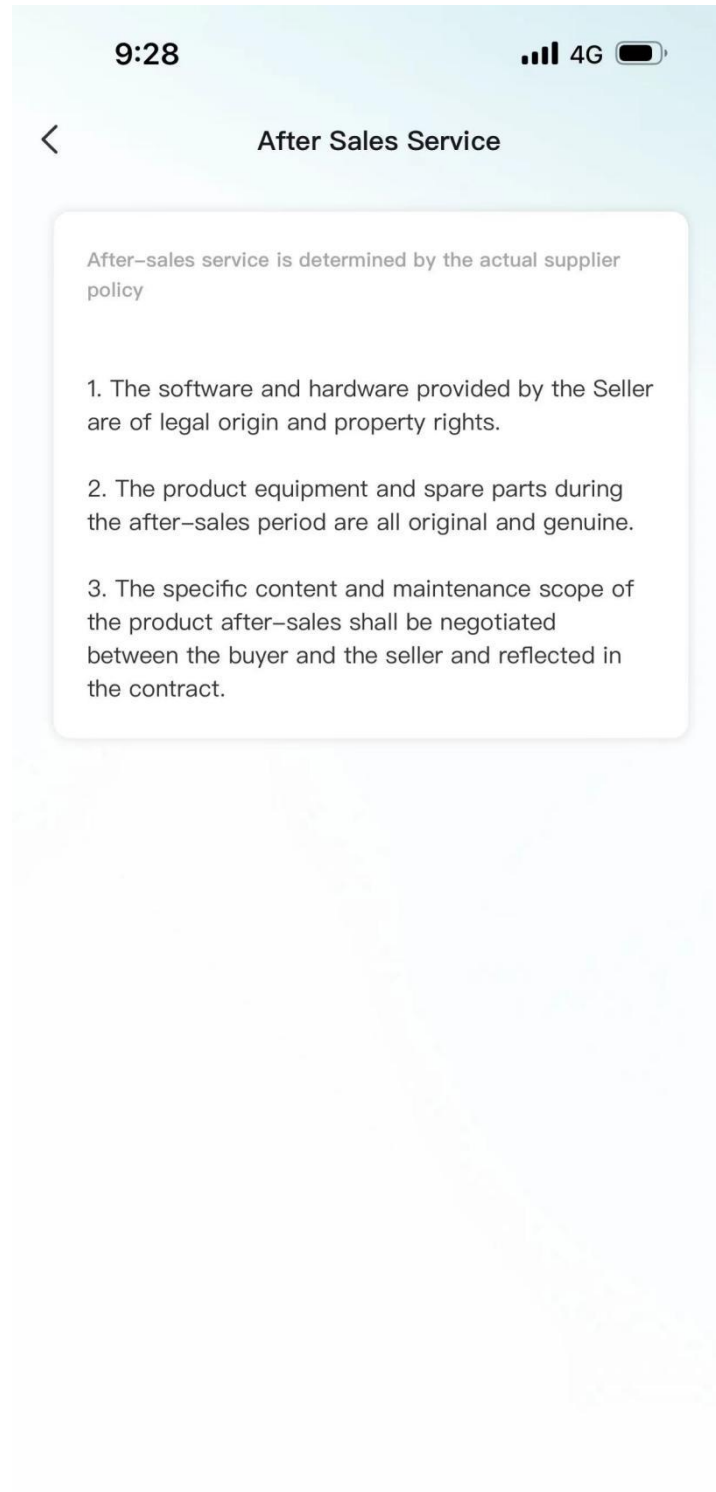

- Click "Feedback" to enter the feedback page. You can enter the current problem that needs feedback and submit it.

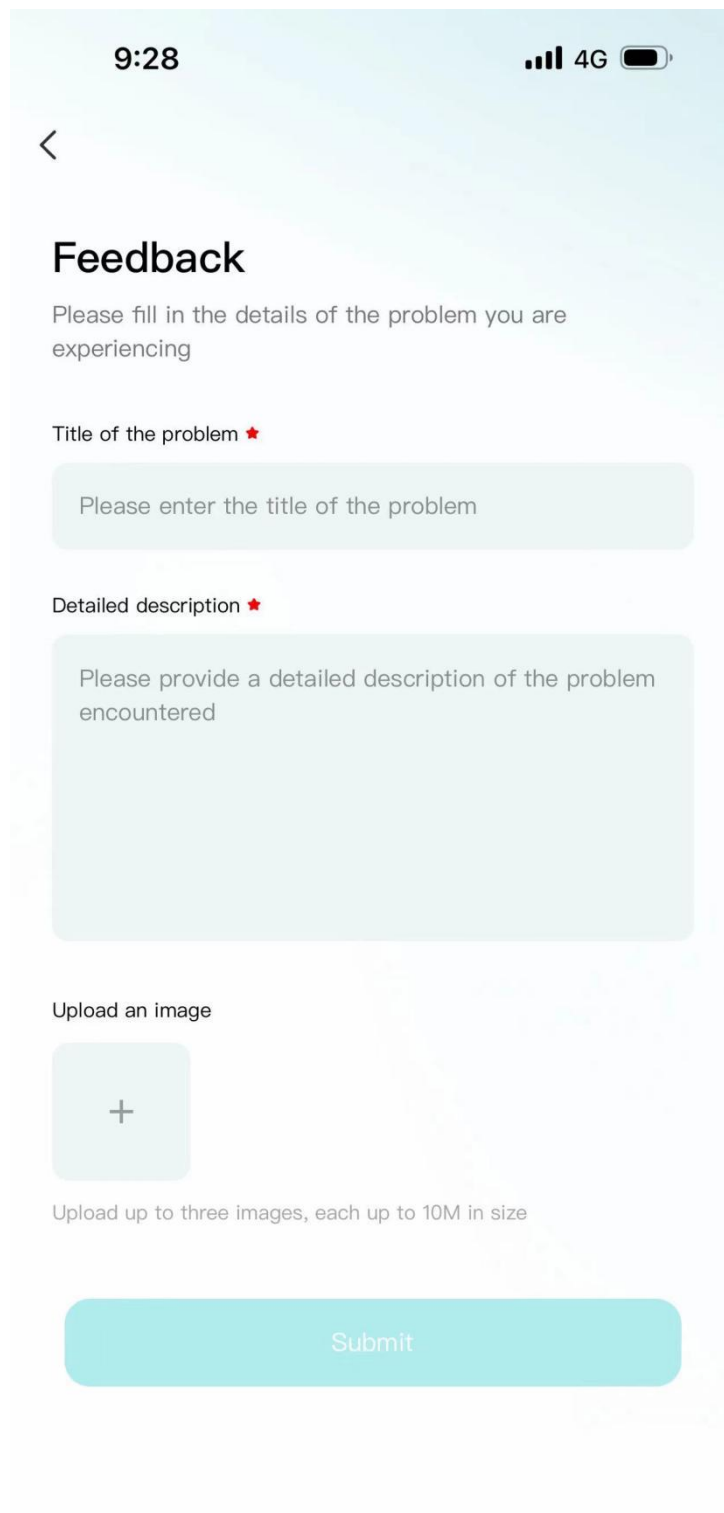

The image shows a mobile application interface for a feedback form. At the top, the status bar displays the time 9:28, 4G signal strength, and battery level. Below the status bar is a back arrow icon. The main heading is "Feedback" in a bold, black font. Underneath, a subtitle reads "Please fill in the details of the problem you are experiencing". The form consists of three main sections: 1. "Title of the problem" with a red asterisk, followed by a light blue rounded rectangular input field containing the placeholder text "Please enter the title of the problem". 2. "Detailed description" with a red asterisk, followed by a larger light blue rounded rectangular text area containing the placeholder text "Please provide a detailed description of the problem encountered". 3. "Upload an image" with a light blue rounded square button containing a plus sign. Below this button is the text "Upload up to three images, each up to 10M in size". At the bottom of the form is a large, teal rounded rectangular "Submit" button. The entire form is set against a light blue background with a subtle pattern of white dots.

4.4.4 Message

Click on the device or my page, the message icon above, you can enter the inbox page

to view the current notification or chat history.

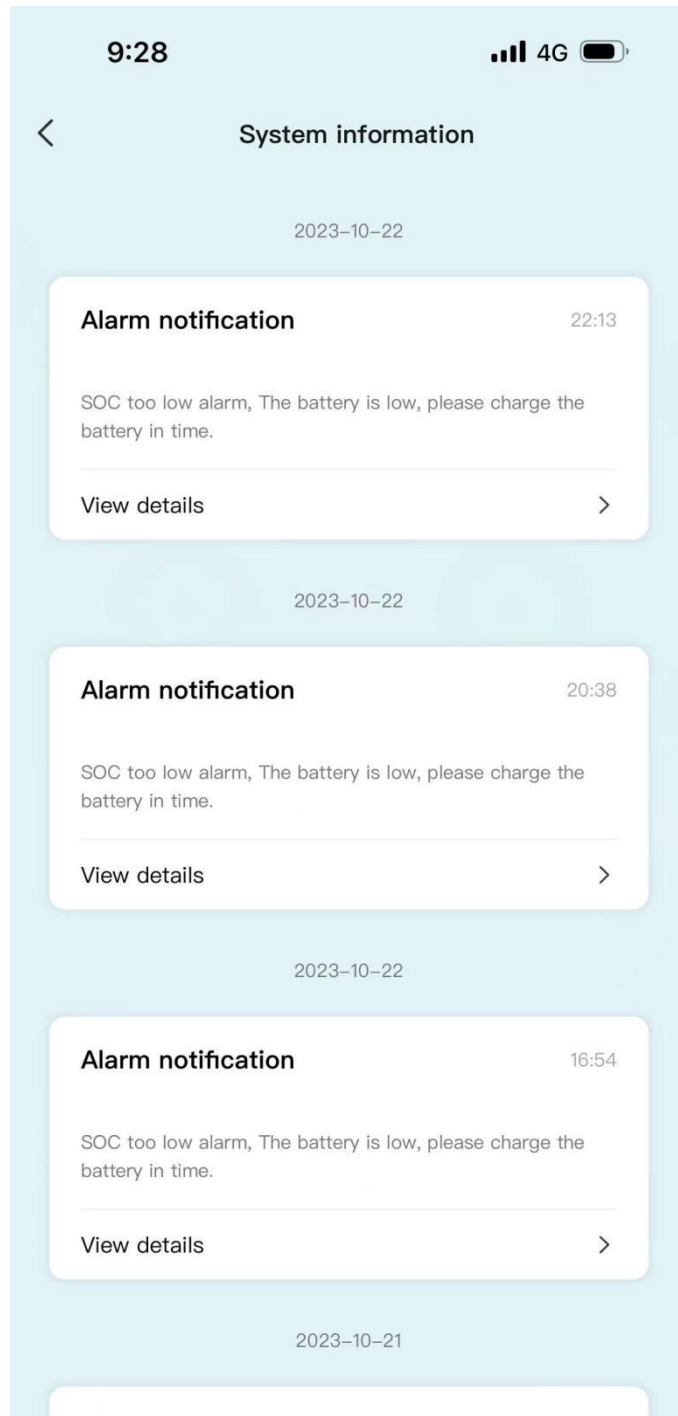

4.4.5 App settings

- Click My Pages - Settings icon in the upper-right corner to enter the App Settings

page.

- Settings page support: language switching, Privacy Policy, cache cleaning, personal information, account and security.

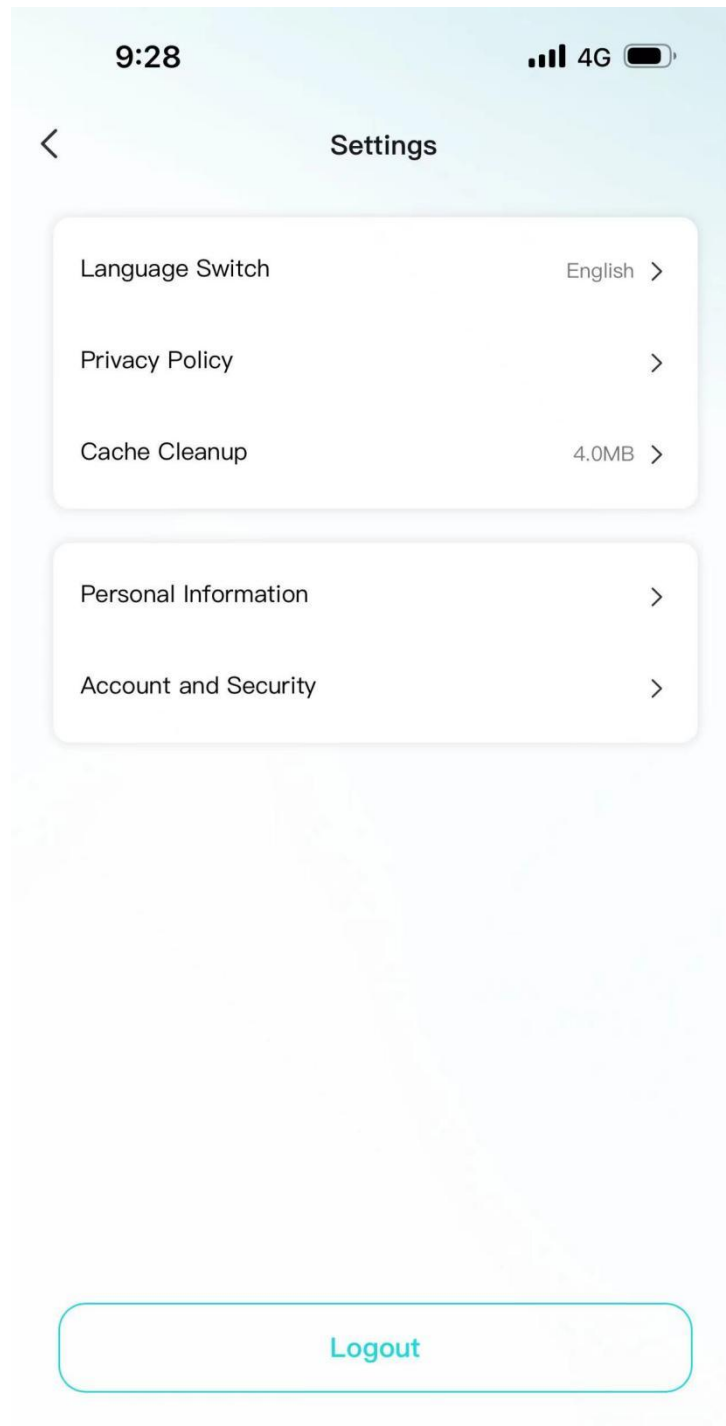

5. Installation and Configuration



5.1 Preparation for installation

5.1.1 Safety Requirement

This system can only be installed by personnel who have been trained in the power supply system and have sufficient knowledge of the power system.

The safety regulations and local safety regulations listed below should always be followed during the installation.

- All circuits connected to this power system with an external voltage of less than 500V must meet the SEHV requirements defined in the IEC60950 standard.
- If operating within the power system cabinet, make sure the power system is not charged. Battery devices should also be switched off.
- Distribution cable wiring should be reasonable and has the protective measures to avoid touching these cables while operating power equipment.
- when installing the battery system, must wear the protective items below:

		
The isolation gloves	Safety goggles	Safety shoes

5.1.2 Environmental requirements

Charging temperature range is 0°C~+45°C,

Discharging temperature range is -10°C ~+55°C

Storage temperature: 0°C~ +35°C

Relative humidity: 5% ~ 85%RH

Elevation: no more than 2000m

Operating environment: Indoor installation, sites avoid the sun and no wind, no conductive dust and corrosive gas.

And the following conditions are met:

- Installation location should be away from the sea to avoid brine and high humidity environment.
- The ground for product arrangement shall be flat and level.
- No flammable explosive materials near the installation site.
- The optimal ambient temperature is 15°C~ 30°C
- Keep away from dust and messy zones

5.1.3 Tools and data

Tools and meters that may be used are shown in table 5-1.

Table 5-1 Tool instrument

NAME	
Screwdriver (Slotted、Phillips)	Multimeter
Torque wrench	Clamp current meter
Diagonal pliers	Insulation tape
Pointed nose pliers	Temperature meter
Pliers to hold the wire	Anti-static bracelet
Stripping pliers	Cable tie
Electric drill	Tape measure

5.1.4 Technical preparation

Electrical interface check

Devices that can be connected directly to the battery can be user equipment, power supplies, or other power supplies.

- Confirm whether the user's PV power generation equipment, power supply or other power supply equipment has a DC output interface, and measure whether the DC power output voltage meets the voltage range requirements in Table 2-2.
- Confirm that the maximum discharge current capability of the DC power interface of the user's photovoltaic power generation equipment, power supply or other power supply equipment should be higher than the maximum charging current of the products used in Table 2-2.

If the maximum discharge capacity of the DC power interface of the user's photovoltaic power generation equipment is less than the maximum charging current of the products used in Table 2-2, the DC power interface of the user's photovoltaic power generation equipment shall have a current limiting function to ensure the normal operation of the user's equipment.

- Verify that the maximum operating current of the battery-powered user equipment (inverter DC input) should be less than the maximum discharge current of the products used in Table 2-2.











The security check

- Firefighting equipment should be provided near the product, such as portable dry powder fire extinguisher.
- Automatic fire fighting system shall be provided for the case where necessary.
- No flammable, explosive and other dangerous materials are placed beside the battery.

5.1.5 Unpacking inspection

- When the equipment arrives at the installation site, loading and unloading should be carried out according to the rules and regulations, to prevent from being exposed to sun and rain.
- Before unpacking, the total number of packages shall be indicated according to the shipping list attached to each package, and the case shall be checked for good condition.
- In the process of unpacking, handle with care and protect the surface coating of the object.
- Open the package, the installation personnel should read the technical documents, verify the list, according to the configuration table and packing list, ensure objects are complete and intact, if the internal packing is damaged, should be examined and recorded in detail.

Packing list is as follows:

Item	Specification	Quantity	Figure
Battery module	51.2V/100AH 5.12Kwh	N	
High voltage battery cluster control box	50A	1	
Battery module base		1	
Positive Cable to inverter	Red/8 AWG /L2000mm	1	
Negative Cable to inverter	Black/8 AWG /L2000mm	1	
Communication Cable to inverter	L2000mm	1	
Communication Cable between batteries	L1000mm	1	
Earthing wire	L2000mm	1	
120 Ω terminal resistance		1	
RJ45 waterproof connector		3	
Screw	M4*16	5	
User Manual		1	

5.2 Equipment installation

5.2.1 Installation Steps

Step 1 Mechanical Installation

(1) Installation step:



Step 4: Install side fastening screws

Step 3: Install the High voltage battery cluster control box

Step 2: Install the Battery module

Step 1: Install the Battery module base

Step 2 Electrical installation

(1) Connect with inverter

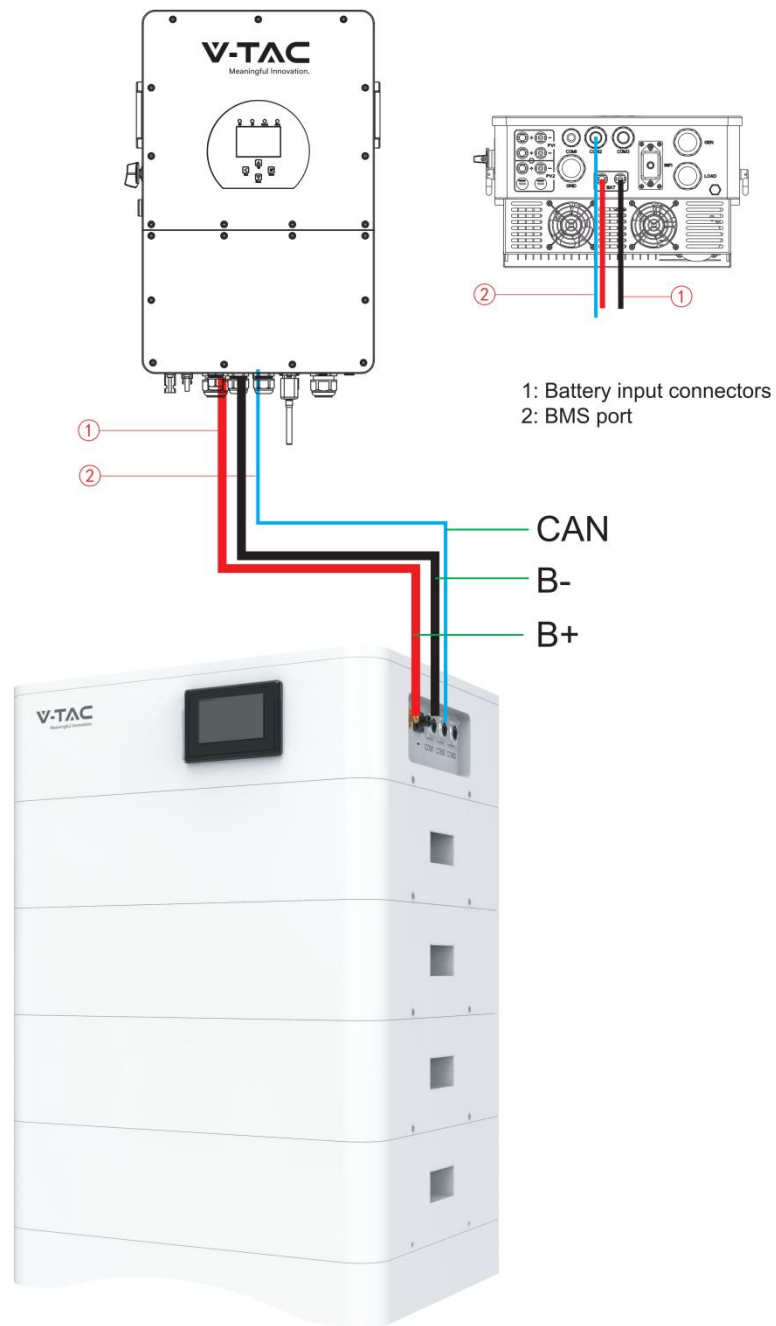

5.2.2 Battery parameter settings on the inverter

If your inverter do not have communication function with OHS-100 battery pack, please set inverter follow next data.

Max Charging(module) Voltage: 56.0V*N

Shut Down(cut off) Voltage: 49.0V*N (SOC20%)

Shut Down(cut off) SOC: 20%

Restart Voltage: 51.2V*N

Max Charge Current: 50A

Max Discharge Current: 50A

6. Installation and Configuration

6.1 Battery system usage and operation instructions

After completing the electrical installation, follow these steps to start the battery system.

1. Open the BMS on/off, wait the screen open and show battery with normal status.
2. After the LCD screen show battery with normal status, open the air switch.



1. After pressing the power button, if the LCD screen show battery with ALM status, please refer to the "6.2 Alarm description and processing ". If the failure cannot be eliminated, please contact the dealer timely.
2. Use a voltmeter to measure whether the voltage of the circuit breaker battery access terminal is higher than 48V*N, and check whether the voltage polarity is consistent with the inverter input polarity. If the circuit breaker battery input terminal has a voltage output and is greater than 48V*N, then the battery begun to work normally.
3. After confirming that the battery output voltage and polarity are correct, turn on the inverter, close the circuit breaker.
4. Check if the indicator of the inverter and battery connection (communication indicator and battery access status indicator) is normal. If it is normal, successfully complete the connection between the battery and the inverter. If the indicator light is abnormal, please refer to the inverter manual for the cause

6.2 Alarm description and processing

When protection mode is activated or system failure occurred, the alarm signal will be given through the system status on the LCD. The network management can query the specific alarm categories.

If the fault such as single cell over voltage, charging over-current, under-voltage protection, high-temp protection and other abnormalities which affects the output, please deal with it according to Table 6-1.

Table 6-1 Main alarm and Protection

Statue	Alarm category	system status	Processing
Charge state	Over-current	Abnormal current	Stop charging and find out the cause of the trouble
	Over-voltage	Cell voltage too high in charge	Stop charging
	High temp	Temperature too high in charge	Stop charging
	Low temp	Temperature too low in charge	Stop charging
Discharge state	Over-current	Abnormal current	Stop discharging
	Low-voltage	Cell voltage too low in discharge	Stop discharging
	High temp	Temperature too high in discharge	Stop discharging
	Low temp	Temperature too low in discharge	Stop discharging

6.3 Analysis and treatment of common faults

Analysis and treatment of common faults in the Table 6-2:

Table 6-2 Analysis and treatment of common faults

No.	Fault phenomenon	Reason analysis	Solution
1	The indicator does not respond after the power on Total voltage lower than 40V*N Check the total voltage	Total voltage lower than 40V*N	Check the total voltage
2	No DC output	Battery data status is abnormal. Battery gets into over-discharged protection	Read the battery information on the monitor.
3	The DC power supply time is too short	Battery capacity become smaller	Storage battery replacement or add more modules
4	The battery can't be fully charged to 100%	Charging voltage is too low	Adjust charging voltage at 57V*N
5	The power cable sparks once power on and ALM light RED	Power connection short-circuit	Turn off the battery, check the cause of the short circuit

6	Communication fault	The battery type of the inverter is wrong/ Communication cable used incorrectly/The communication cable is incorrectly connected at the battery communication port or the inverter communication port/The battery firmware version is too low to support the inverter	Check these possible causes one by one
---	---------------------	--	--

If you need any technical help or have any question, please contact the dealer in time.

7 Battery Module Storage

- ① To ensure the battery service life, the storage temperature shall be kept between 0°C~35°C.
- ② The battery shall be cycled at least once every 6 months.

8 Maintenance



Warning! Improper decommissioning may cause damage to the equipment and/or battery inverter.

Before maintenance, ensure that OHS-100 is decommissioned according to relevant provisions.



Note: All maintenance work shall comply with local applicable regulations and standards.

The USB-CAN port of OHS has the functions of upgrading firmware and recording battery data, which can be used as an auxiliary tool.

To ensure safe operation, all plug connections must be checked. If necessary, relevant operators shall press them back into place at least once a year.

The following inspection or maintenance must be carried out once a year:

- General visual inspection
- Check all tightened electrical connections. Check the tightening torque according to the values in the following table. Loose connections must be retightened to the specified torque.

Connection mode	Tightening torque
high-voltage BMS box grounding	4.5Nm
Fixing the lug of the high-voltage BMS box	1.2Nm
Fixing the lug of the battery module	1.2Nm

- Using the monitoring software, check whether the SoC, SoH, battery voltage and temperature of the battery module are abnormal.
- Shut down and restart OHS-100 once a year.

Note: If the system is installed in a polluted environment, maintenance and cleaning must be carried out at short intervals.

Note: Clean the battery rack with a dry-cleaning cloth. Ensure that no moisture comes into contact with the battery connections. Do not use solvents.



IMPORTANT NOTES:

- This product contains battery type rechargeable.
- Electrical and electronic equipment that has become waste is known as old equipment /device. Old devices must not be disposed of with other household waste.
- Owners of old devices at the end of its service life must return the device by taking them to the collection points set up by public waste disposal authorities or distributors. This return does not entail any costs for you.
- Owners of old devices have an obligation to remove accessible batteries / rechargeable batteries as well as non-destructively removable lamps from the old device prior to return. This does not apply if old devices are being prepared for reuse with the participation of a public law firm.
- Battery removal warning: The battery contained in this product must be removed only by professional personnel only. The battery must never be removed by the end user, if not removed correctly it could damage the battery which could cause fire.
- Batteries removed from an old electronic device should be disposed of separately. This return of battery does not entail any costs for you and the user is obliged to return the battery.
- Please make sure that this product is not powered on when removing the battery. Fire hazard! Avoid short-circuiting the contacts of a detached battery. Do not incinerate the battery. Please handle the battery with Caution!
- If electrical appliances or batteries are disposed of in landfills or dumps, hazardous substances can leak into the groundwater and get into the food chain, damaging your health and well-being.



- The symbol of "Crossed rubbish bins "indicates that this product should not be disposed of with other household wastes and must be collected separately from unsorted municipal
- Please use the link below to view the online directory of the collection and return points:<https://www.ear-system.de/ear-verzeichnis/sammel-und-ruecknahmestellen>

Legal Statement

The information contained in the document is the property of V-TAC Europe Ltd.

All information shall not be published in whole or in part without the written permission of V-TAC Europe Ltd.