



MODEL: GM3125

High voltage insulation tester User's Manual



CONTENTS

1. Before use notice

- Check-up-----(01)
- Safety warning----- (02)
- Feature and function -----(04)
- Specifications -----(05)
- Diagram of the unit -----(07)
- LCD display ----- (09)

2. Operation Instructions

- Preparation before measurement----- (11)
- Voltage measurement----- (12)
- Insulation resistance measurement----- (14)
- Continuous measurement----- (17)
- Timer measurement----- (18)
- Polarization index measurement----- (20)
- The use of green protect-wire----- (23)

3. Other items

- Attentions----- (24)
- Maintenance and warranty ----- (25)

1. Before use notice

Check-up

Carefully unpack your kit and ensure that you have the following items. In case that any items is missing or if you find any mismatch or damage, promptly contact your dealer.

- High Voltage insulation tester-----1pcs
- Red high voltage test wire-----1pcs
- Green test wire----- 1pcs
- Black test wire-----1pcs
- Alligator clip----- 2pcs
- 1.5V LR14 alkaline battery----- 8pcs
- User's manual----- 1pcs
- Soft-bag-----1pcs

Safety warning

Designed to following safety standards:

- IEC 61010-1 CAT. III 600V pollution level: 2
CAT. I 5000V pollution level: 2
- IEC 61010-031 (test wire)
- IEC 61326-1 (EMC)
- IEC 60529 (Ip40)

⚠ Waring:

Electricity is dangerous and can cause injury/ death. For using the instrument correctly and safely, please read this manual carefully and follow the instructions. If you are not quite sure how to proceed, stop and take advice form qualified person.

This instruction manual contains warning and safety rules which user be observed by the user.

The symbol " ⚠ " in this manual have three meanings, please pay attention to the operation with " ⚠ " symbol.

- ⚠ Danger--That conditions/operations may cause serious or fatal injury.**
- ⚠ Warning--That conditions/operations can cause serious or fatal injury.**
- ⚠ Caution--That conditions/operations can cause a injury or instrument damage.**

⚠ Caution

- Before testing, make sure to select proper range.
- After testing, please turn off the tester.





 Danger

- Do not measure if the voltage is above 600V.
- Do not test at flammable / explosive hazard.
- Do not measure if the unit or your hand is wet.
- Do not go beyond the range of the tester
- Do not open the battery door under measuring.
- Do not touch any naked lead under measuring
- Make sure turn off the unit after measurement.

 Warning

- The tester must be operated according to this manual by qualified person who have passed the training.
- Do not open the case while testing. If the tester does not work properly, please return for repair.
- Do not replace the batteries in a humidity condition.
- Make sure the wire firmly connected to the tester.
- Make sure to turn off the power before opening the battery door.
- Check the tester regularly, do not operate if the tester is not normal(such as lead wire is cracked, the case broken etc.)
- Do not attempt any alterations. Please contacted your dealer if the tester need to be repaired.

Symbol:

	Danger of possible electric shock
	Instrument with double or reinforced insulation
	DC
	AC
	Ground terminal

Features and functions

- Auto- discharge function to make, the operation safe.
- LCD Back-light.
- Digital readout display.
- Live circuit warning symbols with audio sounds.
- Auto- power off function (in 10 minutes without operation)
- Timer measurement function.
- Low battery indication
- PI measurement (Polarization index measurement)
- Suitable for 12V DC adapter (12V/1A)

Specifications:

1. Insulation resistance tester:

Rated voltage	500V	1000V	2500V	5000V
Test range	0.0~99.9MΩ	0.0~99.9 MΩ	0.0~99.9 MΩ	0.0~99.9 MΩ
	100~999MΩ	100~999 MΩ	100~999 MΩ	100~999 MΩ
		1.00~1.99GΩ	1.00~1.99GΩ	1.00~9.99GΩ
			10.0~99.9GΩ	10.0~99.9GΩ
			100~1000GΩ	100~1000GΩ
Open circuit voltage	DC 500V +30%, -0%	DC 1000V +20% -0%	DC 2500V +20% -0%	DC 5000V +20% -0%
Rated current	0.5MΩloading 1mA~1.2mA	1MΩ loading 1mA~1.2mA	2.5MΩ loading 1mA~1.2mA	5MΩ loading 1mA~1.2mA
Short-circuit current	Approx. 1.3mA			
Accuracy	±5%rdg±3dgt (0~99.9GΩ) ±20%rdg±3dgt (above 100GΩ)			

2. Voltage tester:

30~600V (Resolution 1V)

	DV	AV
Measuring range	±30~±600V	30~600V (50/60Hz)
Resolution	1V	
Accuracy	±2%rdg±3dgt	

3. Technology parameter:

Technology parameter	Technology index
Display	Max. 999 counts LCD display (1000 counts only at 1T is displayed)
Over range indication	OL mark appears on insulation resistance range. LO mark appears on voltage's range.
Auto- ranging	Range shifts to upper range: 1000 count Range shifts to lower range: 95 counts (merely on the insulation resistance range)
Sample rate	0.5~ 10 times/sec
Operable altitude	Less than 2000m (Indoor use)
Operation circumstance	Temperature 0~40C, humidity <= 85%
Storage circumstance	Temperature -20~ 60C, humidity <= 90%
Overload protection	Insulation resistance : AC 1200V/ 10s Voltage : AC 720V/ 10 s
Voltage resistance	AC8320 (50/60Hz)/ 5 second (between electrical circuit and enclosure)
Insulation resistance	1000M of more/ DC 1000V (between electrical circuit and enclosure)
Power supply	DC12V (8x1.5V LR14 battery)
Battery's life	Approx. 15 hours
Dimension	153x 96x 200mm
Weight	1032g (without batteries and test wires)

Diagram of the unit

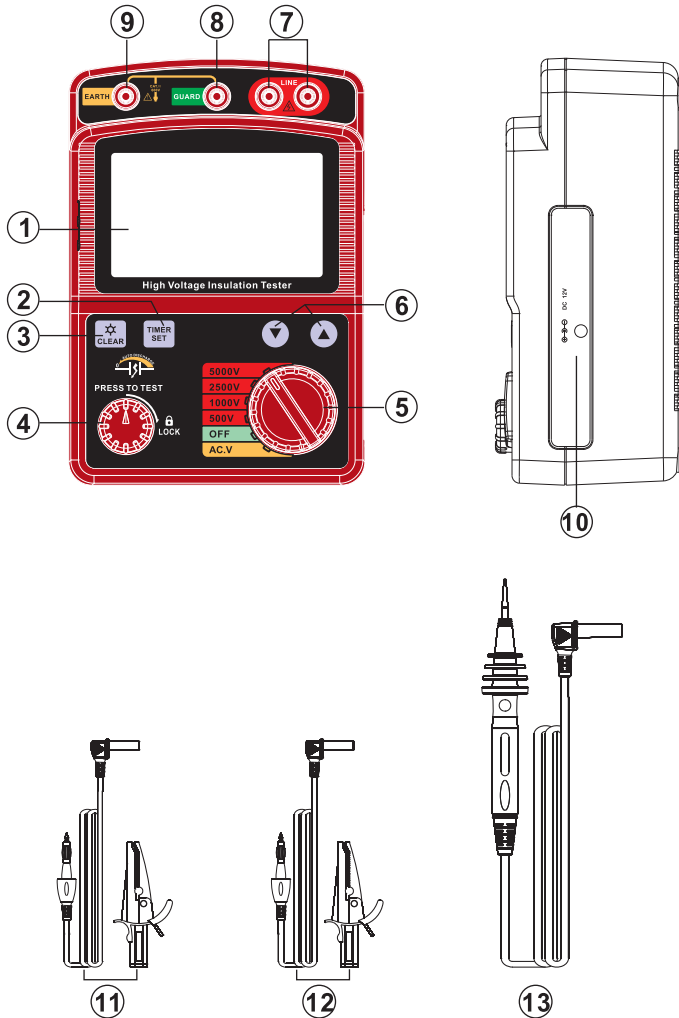

1.LCD display.

2.  : Time set button.

3.  :.Backlight button

4.Test button.

5.Function switch.

6.  : Time choose button.

7.Red high voltage test wire socket.

8.Green protect test wire socket.

9.Black test wire socket.

10.DC input interface (12V/1A)

11.Black test wire and alligator clip.

12.Green protective test wire and alligator clip.

13.Red Hi- volt test wire.



Caution

The data in the diagram of the unit is a simple instruction.
Read the operation to get a detail operation guidance.

LCD Display

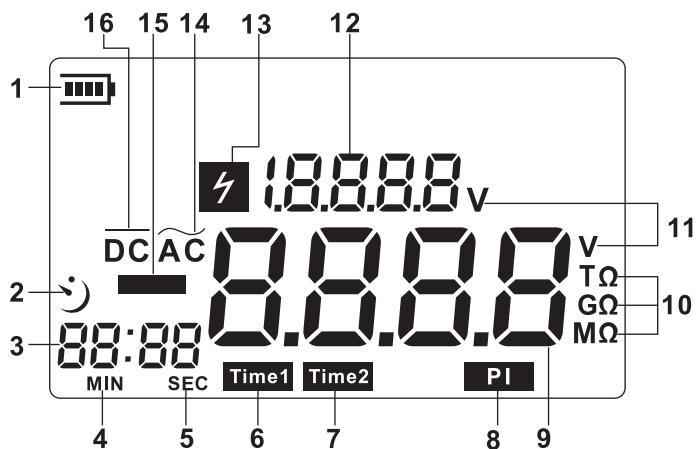

1. : Battery symbol;
2. : Time count down symbol;
3. Timing display ;
4. **MIN** :Minute;
5. **SEC** :Second;
6. **Time1** :Timers 1;
7. **Time2** :Timers 2;
8. **PI** :Polarization index
9. Voltage/ insulation resistance reading.
10. Resistance unit
11. **V** :The voltage unit
12. Voltage display section
13. :High voltage warning .
14. :Alternating current .
15. :Minus symbol.
16. :Direct current .

2.Operation instructions

Preparation before measurement

1. Check the battery voltage & battery replacement:
 - a. Set the function switch to any position other than OFF.
 - b. When the battery mark shown at the upper left on the LCD is “”, the battery is almost exhausted. Replace the batteries to proceed to measurement. When battery mark is “”, the battery voltage is below the lower limit of the operating voltage. The accuracy cannot be guaranteed.
 - c. Battery replacement:
 - 1>. Take down all the test line after you turn off the instrument.
 - 2>. Uninstall four screws at the bottom and open the battery door.
 - 3>. Replace all old batteries with new batteries. Please note the polarity.
 - 4>. Cover the battery door and fasten the screws. As the picture below:

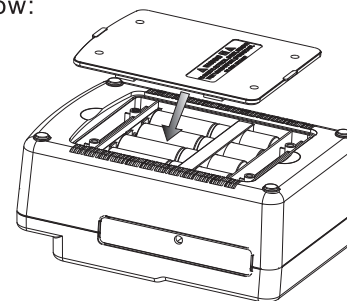

Caution:
Remove the batteries if the tester is not required for an extended periods in order to avoid damage to the battery compartment and erosion resulting from a battery leakage.

2. Connecting test wires:

Insert the test wire firmly to the connector terminal on the instrument;

Connect the red test wire to “Line” socket;

Connect the black test wire to “Earth” socket;

Connect the green guard wire to “Guard” socket;

The connect method like the picture below:

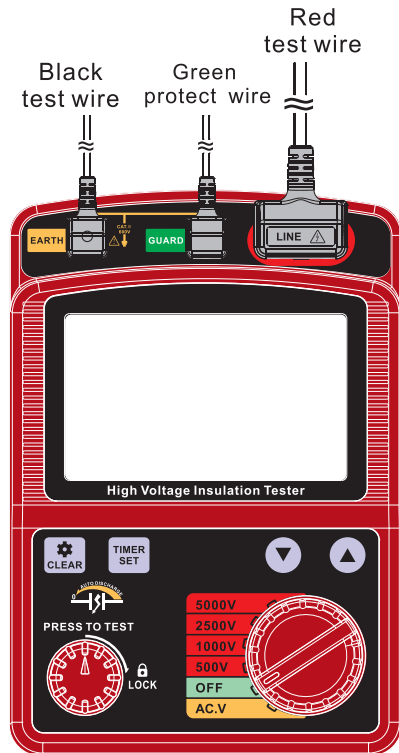

-11-

Voltage measurement(30~600V)

⚠ Danger

- Do not take measurement on a circuit above AC/ DC 600V
- The user maybe hazard when testing installation that has a large current capacity, do not touch any bare wire at this time.
- Do not take measurement if the battery cover removed.

1. Connect the red test lead and black test lead to reciprocal terminal socket.

2. Set the function switch to "AC. V" position, like the picture below: Don't press "Test" button, this instrument with DC/AC self-detection and DC voltage +/- identification function.

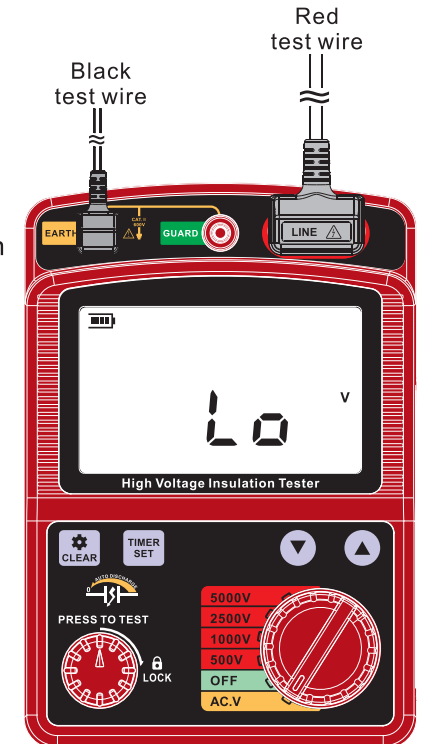

-12-

3. Connect the red or black test pin to the pole, if the beam is dim you can press the  " " button to turn on back light. The LCD display shown as below:

- Connect the red pin which test direct voltage to +, connect the black to -, LCD display as below:



- Connect the red pin which test direct voltage to-, connect the black to +, LCD display as below:

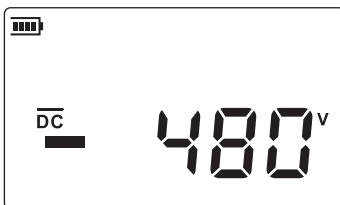

- LCD display as below when test AC:



4. Remove the test pin after measurement. Then set the function switch to OFF position.

Insulation resistance measurement

⚠ DANGER

- Make sure that there is no electrical charge exists on the circuit under test.
- Make sure to put on a pair of insulated gloves for high voltage.
- Do not take measurement when thunder rumbling.
- Do not take measurement if the battery cover removed.

⚠ Caution

- Do not take measurement when the live circuit wiring is active.

1. Connect the red test wire and black test wire to reciprocal terminal socket.
2. Setting the function switch to proper position according to the content of insulation material, (you can take a try follow the sequence 500V/ 1000V/ 2500V/5000V if you do not know the resistance range) for example, 2500V:

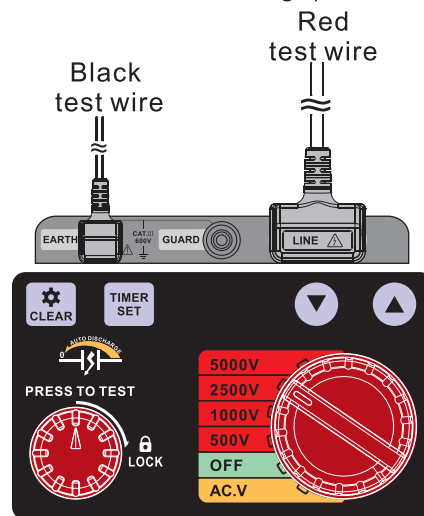

After a full screen display, LCD display as below:

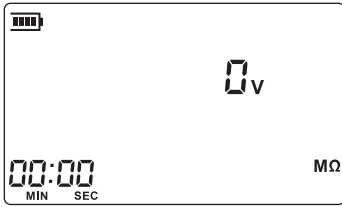

3. Connect the test pin/clip to the unit tested, Press the test button to measure, the buzzer will sound continuously and the high voltage light will be activated. LCD display as below:

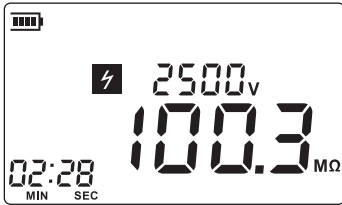

4. Release the button, the instrument will discharge the high voltage automatically, and the high voltage light and the sound of the high voltage will stop. Only remove the test wires when LCD display 0V. LCD display the tested time and insulation resistance as below:

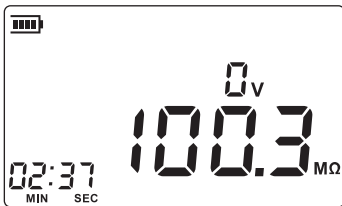

⚠ Danger

- Do not touch the circuit under test immediately after testing. Capacitance stored in the circuit may cause electric shock.

5. Remove the terminal pins/alligator to the part under test then turn off the unit.
6. The test principle of the insulation resistance:
Resistance value can be obtained by applying a certain high voltage to trigger following current $R=V/I$.

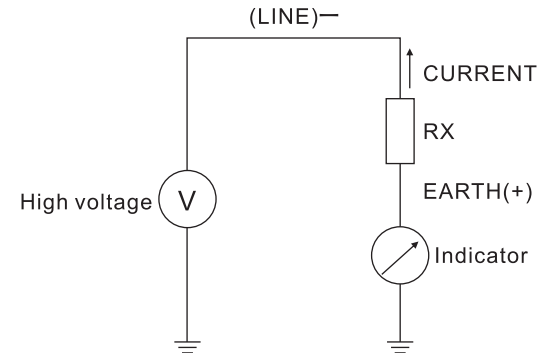

Caution:

1. It consumes 25mA current when the function switch is at any position other than OFF (Auto- power - off: Approx 1uA). Set the function switch to OFF position when. Not use the instrument.
2. The test switch of this instrument have two test methods:
 - a. Instant measurement: press the TEST button only, it produces high voltage to test insulation resistance. Release the button, the measurement will stop.
 - b. Continuous measurement: press the TEST button and rotate to lock the switch to take measure continuously. Turn the TEST button to anti-clockwise and release it, the tester will stop the measurement.
3. To make sure safety of measurement and the instrument. Choose 500V lever when the insulation resistance is less than 50mΩ.

Continuous measurement

1. About the first and second procedure, please refer to INSULATION RESISTANCE MEASUREMENT.
2. Connect the test pin/clip to the unit tested. Press and Rotate the PRESS TO TEST button clockwise to perform a continuous measurement. The buzzer will sound at this time. LCD display as below:

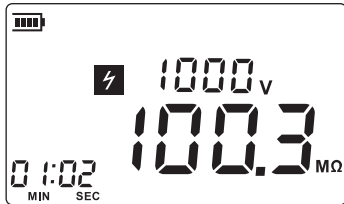

After measurement, rotate the test button original position in anticlockwise, The instrument will discharge the high voltage automatically, the high voltage light and sounds will stop. Remove the test wires only when LCD display 0V, LCD display as below:

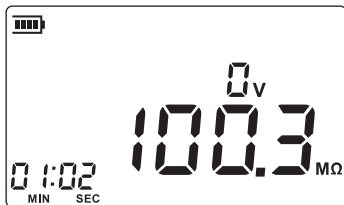

3. Remove the test wires firstly, then set the function switch to OFF position.

Timer measurement

This is a function to conduct a test automatically at any set time.

1. About the first and second procedure, please refer to INSULATION RESISTANCE MEASUREMENT.
2. Press the "TIMER SET" button and TIME1 mark will be displayed.
3. Press ▲ or ▼ button to set up times, for example, 30 second. LCD display as below:



4. Press and rotate the PRESS TO TEST button clockwise to perform a timer measurement of insulation resistance, the buzzer will sound and the "Time1" will flash, LCD display as below:

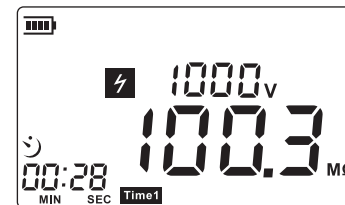

5. Measurement automatically stop when the time exhausted at the set time, The high voltage light turns off and the sound of the high voltage stop. Rotate test button back to the original position in anticlockwise. LCD display as below:

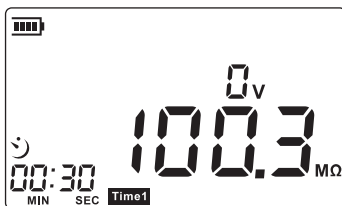

Caution:

Press ▲ or ▼ button, time can be set at every 5sec form 00:00 to 01:00, after that rang time can be set at every 30sec.

Polarization index measurement

1. About the first and second procedure, please refer to INSULATION RESISTANCE MEASUREMENT.
2. Press the "TIMER SET" button, TIME1 mark will displayed, and then press ▼ or ▲ button to set time, for example: 1 min; Press the "TIMER SET" button and TIME2 mark will displayed, then press ▼ or ▲ button to set time, for example: 10 min. LCD will display like the followed picture:



4. Connect the test nip/clip to the insulation material under test. Press and turn clockwise the test button clockwise. The buzzer will sound, the Time1 and PI will flash when measure insulation resistance at "Time1", Time2 and PI will flash when measure insulation resistance at "Time2", LCD display as below:

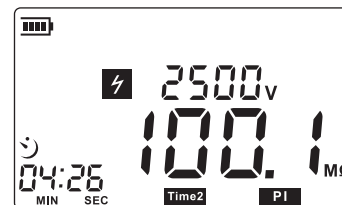

5. When the measurement is completed at TIME2, the high voltage light get off and the sound of the high voltage stop. Turn test button back to the original position anticlockwise, the rate (insulation resistance of TIME2/ insulation resistance of TIME1)display as below:



6. Press the  button at the first time: LCD display the insulation resistance value of TIME1 like the followed picture:

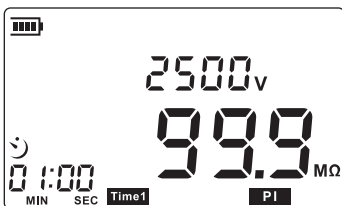

- Press the  button at the second time: LCD will display the insulation resistance value of TIME2 like the followed picture:

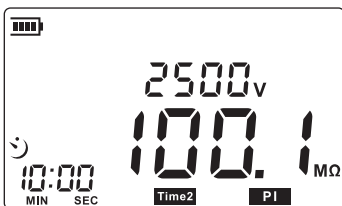

Press the  button at the third time, LCD will display the Polarization index value.

7. Polarization index measurements usually set TIME 1 to 1 min. set TIME2 to 10min.

$$\text{Polarization index} = \frac{\text{Resistance value in 10 min (TIME2)}}{\text{Resistance value in 1 min (TIME1)}}$$

Polarization index	4 or more	4- 2.0	2.0- 1.0	1.0 or les
Criteria	Very good	Good	Dubiouts	Unsatisfactory



Caution

The data shown in the operation instruction are merely an example to illustrate, please refer to the value obtained in your practice.

The use of green protect- wire

Connect the green protect- wire to GUARD terminal. It is only used to measure the insulation resistance of cable. Nip the shield like during the measurement to reduce the effect of leakage current (please reference before test instruction to understand other operation). Connect the wires as below:

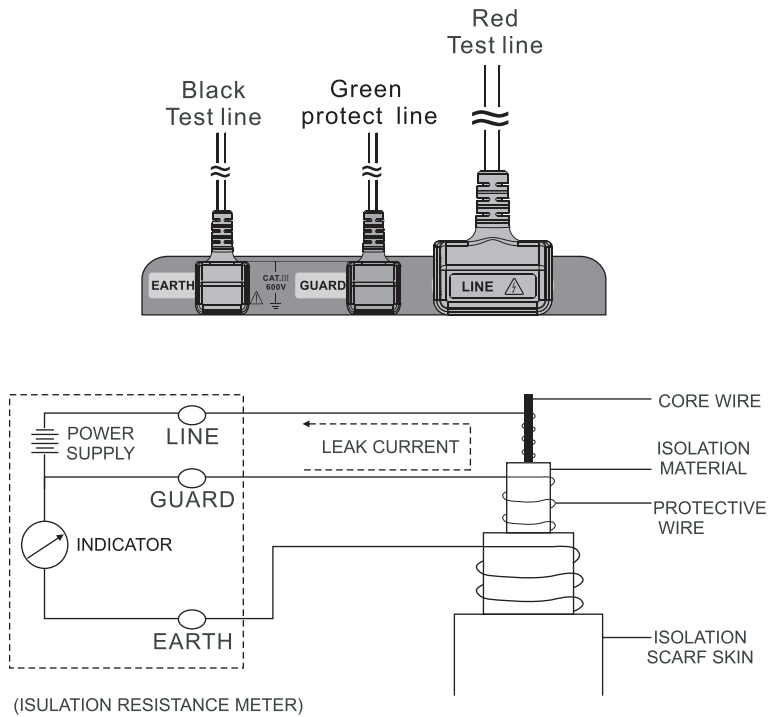

Other items

Attentions:

1. The screen is vacant after turn on the instrument:
Check whether the battery is installed correctly. Open the battery door, check the symbol + - on the battery must accord with symbol on the battery compartment.
2. If the battery voltage lower than $8.5v \pm 0.2v$ and the LCD displays low battery indication, please replace the battery to avoid the in-correct reading.
Please read the page 10 of operation instruction for the battery replacement operation.
3. The connect way of test pin with alligator clip is like the following picture:

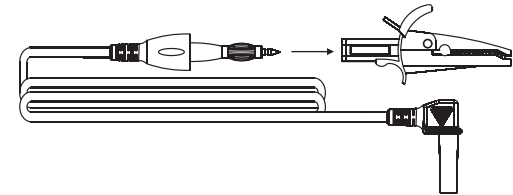

4. Remove the battery form the instrument if it is not required for extended period of time in order to avoid damage to the battery compartment and the electrode resulting from a battery leakage.

Maintenance and warranty

Maintenance:

1. Do not store or use the unit in following locations where the unit may be subject to:
 - a. Splashes of water or high levels of dust.
 - b. air with high salt or sulphur content.
 - c. Air with other gases or chemical materials.
 - d. High temperature or humidity (above 60°C, 90%,) or direct sunlight.
2. Do not disassemble the unit or attempt internal alterations.
3. Never use alcohol or thinner to clean the unit casing that will especially erode the LCD surface; just clean the unit lightly as needed with little clean water.

Warranty:

1. About relative warranties please read warranty card.
2. We disclaim any liability due to: client's transportation damages; incorrect use or operation; manipulation, alterations or repair attempts.



Statement

- a. We reserve the rights of upgrading and amending the design of the product as well as the manual updating, and the product is subject to change without any further notification.
- b. Dispose of battery should be in accordance with local laws and regulations.